



AGENA CONSTRUCTION AND INDUSTRIAL COLLEGE

Industrial Electrical/Electronic Control Technology Level-II

Based on March, 2022 Curriculum Version 1



**Module Title: - Rewinding Single/Three Phase
Induction Machine**

Module code: EIS IEC2 M10 0322

Nominal duration: 150Hour

**Prepared by: - AGENA CONSTRUCTION AND INDUSTRIAL
COLLEGE**

**September, 2022
Agena, Ethiopia**

Page 2 of 124	Author/Copyright :- AGENA CONSTRUCTION AND INDUSTRIAL COLLEGE	Rewinding Single/Three Phase Induction Machine	Version -1 August, 2022
---------------	---	---	----------------------------



AGENA CONSTRUCTION AND INDUSTRIAL COLLEGE

Table Contents

Introduction to the Module	7
Unit one: Preparation to rewind single/three phase induction machines	9
1.1. OHS & WHS Requirements and Procedures	10
1.2. Tools, equipment, testing device and isolating Machines/equipment	11
1.2.1. TOOLS	11
1.2.2. Test Instruments.....	11
1.3. Winding data from records and measurements of stator and core	13
1.3.1 Name plate or External Data	13
1.3.2. Internal Data.....	14
1.3.3. Speed of an Induction Motor	16
1.3.4. Number of poles/synchronous.....	17
1.4. Materials for rewinding single/three phase induction machine.....	20
1.4.1 Winding insulating materials.....	20
1.5. Scope of work in rewinding induction machine	24
1.5.1. Motor overhauling.....	24
1.5.2. Optional Jobs, Motor Overhauling	25
1.5.3. Inspection and testing	26
1.6. Common terms to motor windings	26
1.7. Application of testing techniques to collected data.....	57
Self-check-1	69
Operation Sheet 1.1 Data collection for rewinding.....	72
Operation Sheet 1.2 Data collection for rewinding.....	75
LAP Test 1. Draw complete winding diagram of three phase Ac motor	80
Unit Two: Windings of Electrical coils	81
2.1 Preparation of winding electrical coils.....	82
2.2. Winding of small and medium-sized solenoid coils, contactor coil.....	86
2.3. Assembling processes.....	87
2.4. Risk minimization in case of unplanned events	88



AGENA CONSTRUCTION AND INDUSTRIAL COLLEGE

Self-Check 2.....	89
Operation Sheet 2: Electrical coil winding.....	91
LAP Test 2: Wind contactor coil	92
Unit Three: Procedures to rewind single/three phase induction machine.....	93
3.1. Part dismantle, tag and store to prevent loss.	93
3.2. Techniques of stripping winding from stator.	93
3.3. How to Wind and insulate Stator:	94
3.4. Inspection and testing of ac machine	94
3.5. Completion of electrical coil work within timeframe	96
3.6. Respond unplanned situations in a manner that minimizes risk	97
3.7. Quality checks on winding of induction machines	97
Self-check 3	98
Operation Sheet 3.1 Three phase ac motor winding.....	101
Operation Sheet 3.2: Three phase ac motor winding.....	106
LAP Test 3: Rewind of Three phase Ac induction Motor	110
Unit Four: Completion of workplace report	111
4.1. Process of checking standards and requirements.....	111
4.2. Procedures for checking assembled products.....	112
4.3. Follow completion of workplace report/forms	115
4.4. Completion of workplace report.....	116
Self check 4	120
Operation Sheet 4. Workplace report	122
LAP Test 4: Report writing	122
Reference.....	123
No.....	Error! Bookmark not defined.

Page 4 of 124	Author/Copyright :- AGENA CONSTRUCTION AND INDUSTRIAL COLLEGE	Rewinding Single/Three Phase Induction Machine	Version -1 August, 2022
---------------	---	---	----------------------------



AGENA CONSTRUCTION AND INDUSTRIAL COLLEGE

Acknowledgment

Ministry of Labor and Skills wish to extend thanks and appreciation to the many representatives of TVT instructors and respective industry experts who donated their time and expertise to the development of this Teaching, Training and Learning Materials (TTLM).

Page 5 of 124	Author/Copyright :- AGENA CONSTRUCTION AND INDUSTRIAL COLLEGE	Rewinding Single/Three Phase Induction Machine	Version -1
			August, 2022



AGENA CONSTRUCTION AND INDUSTRIAL COLLEGE

Acronym

LAP	Learning Activity Performance
OHS	Occupational Health and Safety
WHS	Work Health and Safety
EEPCO	Ethiopian Electric Power Corporation
HP	Horse Power
NS	Synchronous Speed
RPM	Revolution Per Minute
RMF	Rotating Magnetic Flux
VVVF	Variable Voltage Variable Frequency
emf	Electromagnetic flux
DWV	Dielectric Withstanding Voltage
IEEE	Institute of Electrical Electronics Engineers
HV	High Voltage
LV	Voltage Voltage
TTR	Transformer Turn Ratio
ISO	International Organization for Standardization
QMS	Quality Management System

Page 6 of 124	Author/Copyright :- AGENA CONSTRUCTION AND INDUSTRIAL COLLEGE	Rewinding Single/Three Phase Induction Machine	Version -1 August, 2022
---------------	---	---	----------------------------



AGENA CONSTRUCTION AND INDUSTRIAL COLLEGE

Introduction to the Module

In industrial electrical/electronic control technology; rewinding single/three phase induction machine helps to know the basics of machine rewinding; to understand constructional parts of induction machine; to know operation principle of induction machines; to differentiate different types of induction machine: to draw complete winding diagram; to prepare electrical coils; to rewind induction machine; to test induction machine; and to report after completion of rewinding work.

This module is designed to meet the industry requirement under the industrial electrical/electronic control technology occupational standard, particularly for the unit of competency: **Rewind single/three phase induction machines.**

This module covers the units:

- Preparation to rewind single/three phase induction machines
- Windings of Electrical coils
- Procedures to rewind single/three phase induction machine
- Completion of workplace report

Learning Objective of the Module

- Prepare to rewind single/three phase induction machines
- Perform windings of electrical coils
- Apply procedures to rewind single/three phase induction machine
- Complete workplace report

Page 7 of 124	Author/Copyright :- AGENA CONSTRUCTION AND INDUSTRIAL COLLEGE	Rewinding Single/Three Phase Induction Machine	Version -1
			August, 2022



AGENA CONSTRUCTION AND INDUSTRIAL COLLEGE

Module Instruction

For effective use this modules trainees are expected to follow the following module instruction:

1. Read the information written in each unit
2. Accomplish the Self-checks at the end of each unit
3. Perform Operation Sheets which were provided at the end of units
4. Do the “LAP test” given at the end of each unit and
5. Read the identified reference book for Examples and exercise

Page 8 of 124	Author/Copyright :- AGENA CONSTRUCTION AND INDUSTRIAL COLLEGE	Rewinding Single/Three Phase Induction Machine	Version -1
			August, 2022



AGENA CONSTRUCTION AND INDUSTRIAL COLLEGE

Unit one: Preparation to rewind single/three phase induction machines

This unit is developed to provide you the necessary information regarding the following content coverage and topics:

- OHS & WHS requirements and procedures
- Tools, equipment, testing device and isolating Machines/equipment
- Winding data from records and measurements of stator and core
- materials for rewinding induction motor
- Scope of work in rewinding induction machine
- Common terms to motor windings
- Application of testing techniques to collect data

This unit will also assist you to attain the learning outcomes stated in the coverage. Specifically, upon completion of this learning guide, you will be able to:

- Follow OHS & WHS requirements and procedures
- List tools, equipment, testing device and isolating Machines/equipment
- Take winding data from records and measurements of stator and core
- Prepare materials for rewinding single/three phase induction machine
- Understand the scope of work in rewinding induction machine
- Familiarize with common terms in motor windings
- Apply testing techniques to collect data

Page 9 of 124	Author/Copyright :- AGENA CONSTRUCTION AND INDUSTRIAL COLLEGE	Rewinding Single/Three Phase Induction Machine	Version -1 August, 2022
---------------	---	---	----------------------------



AGENA CONSTRUCTION AND INDUSTRIAL COLLEGE

1.1. OHS & WHS Requirements and Procedures

- Machine rewinding is vulnerable to accident because of high speed moving machine, chemical exposure, and injury due to physical stress.
- Ergonomic hazards occur when the type of work, body positions and working conditions put a strain on your body. They are the hardest to spot since you don't always immediately notice the strain on your body or the harm that these hazards pose. Short-term exposure may result in "sore muscles" the next day or in the days following the exposure, but long term exposure can result in serious long-term illness. There may be lifting of heavy machines under the task of rewinding so be sure to use appropriate weight lifting method.
- The workplace occupies a lot of your daily time, so that should be the reason to arrange it in a way, that the work can be done relaxed and efficient.
- The whole workplace with its tools, materials and equipment also has to be arranged in such a way that accidents are impossible to happen
- Do not give access to your workshop to persons who are not aware of electrical hazards
- Keep your workplace always clean and in order
- To avoid electrical hazards, the floor under your workplace has to be insulated
- Chemicals, which can affect the health of human beings, or can cause any damage to tools, material and equipment and installations, have to be stored in a locked compartment.

Page 10 of 124	Author/Copyright :- AGENA CONSTRUCTION AND INDUSTRIAL COLLEGE	Rewinding Single/Three Phase Induction Machine	Version -1 August, 2022
----------------	---	---	----------------------------



AGENA CONSTRUCTION AND INDUSTRIAL COLLEGE

1.2. Tools, equipment, testing device and isolating Machines/equipment

1.2.1. TOOLS

A. Electrician hand tool set: Which contains different tools for electrical work on low voltage range?

Nut-spinner set: for tightening or loosening nut and bolts. The socket fits around and grips around the entire head of the fastener for secure fit.



Figure 1.1 Nut spinner

B. Wrenches

A wrench or spanner is a tool used to provide grip and mechanical advantage in applying torque to turn objects usually rotary fasteners, such as nuts and bolts or keep them from turning. It may be Allen Wrench or Combination wrench (Open and box end at each tip)

1.2.2. Test Instruments

A. Clamp ammeter

A Clamp Ammeter is an electrical device having two jaws which open to allow clamping around an electrical conductor. This allows properties of the electric current in the conductor to be measured, without having to make physical contact.

Page 11 of 124	Author/Copyright :- AGENA CONSTRUCTION AND INDUSTRIAL COLLEGE	Rewinding Single/Three Phase Induction Machine	Version -1 August, 2022
----------------	---	---	----------------------------



AGENA CONSTRUCTION AND INDUSTRIAL COLLEGE

A. Insulation resistance tester (Megger)

Megger is an instrument used for measuring the insulation resistance of electrical devices (ex. Induction motor winding).

B. Ground Resistance Tester

Ground resistance tester is used for testing earth electrodes and the measurement of soil resistivity.

C. Earth Leakage Tester

Instrument used for measuring ground / earth leakage currents in electrical systems

D. Tachometer

A tachometer (revolution-counter, tach, rev-counter, RPM gauge) is an instrument measuring the rotation speed of a shaft or disk, as in a motor or other machine.

E. Phase Sequence Tester

The Phase Sequence Indicator is used to determine the phase sequence (A-B-C or C-B-A) of three-phase voltages. It is important that phase sequence is known prior to energizing electrical motors and other equipment, as incorrect connection could cause damage to the equipment

Table 1.1 Lists of Equipment

1	Motor/transformer automatic rewinding machine
2	Bench-Vise
3	Manual rewinder
4	Motor holder
5	Wire holder
6	Coil's removing machine
7	Baking oven
8	Coil's counter machine
9	Bearing puller

Page 12 of 124	Author/Copyright :- AGENA CONSTRUCTION AND INDUSTRIAL COLLEGE	Rewinding Single/Three Phase Induction Machine	Version -1
			August, 2022



AGENA CONSTRUCTION AND INDUSTRIAL COLLEGE

10	Soldering with soldering lead
----	-------------------------------

1.3. Winding data from records and measurements of stator and core

Data collected of motor affect the specification in which the motor is designed, so that correct data of original must be collected to get the motor operation as the original one.

The following data must be collected in order to rewind electrical motors to original specifications.

1.3.1 Name plate or External Data

Voltage rating: - this tells the maximum voltage that should be supplied to the motors.

No. of phase: this data indicates that whether the motor/transformer is three phases or single phase

Frequency: operating supply frequency (50Hz EEPCO standard)

Current rating: maximum rated current drawn by the machine at full load.

Power rating: this is the power consumed by the machine at full load, it may given in kilowatt or horse power (1 HP = 746 watts).

Serial no.: production number assigned by manufacturer.

Service factor: is a measure of periodically overload capacity at which a motor can operate without overload or damage.

Weight: maximum weight of the motor/transformer without load.

Temperature: operating temperature in room temperature level.

Connection: this indicates for three phases machine whether star or delta connected machines

Terminal markings: terminals of three phase motor may be indicated as (U, V, W to X, Y, Z respectively or U1, V1, W1 to U2, V2, W2) and for single phase motors U1 to U2 for running and Z1 and Z2 for starting/auxiliary winding.

Page 13 of 124	Author/Copyright :- AGENA CONSTRUCTION AND INDUSTRIAL COLLEGE	Rewinding Single/Three Phase Induction Machine	Version -1 August, 2022
----------------	---	---	----------------------------



AGENA CONSTRUCTION AND INDUSTRIAL COLLEGE

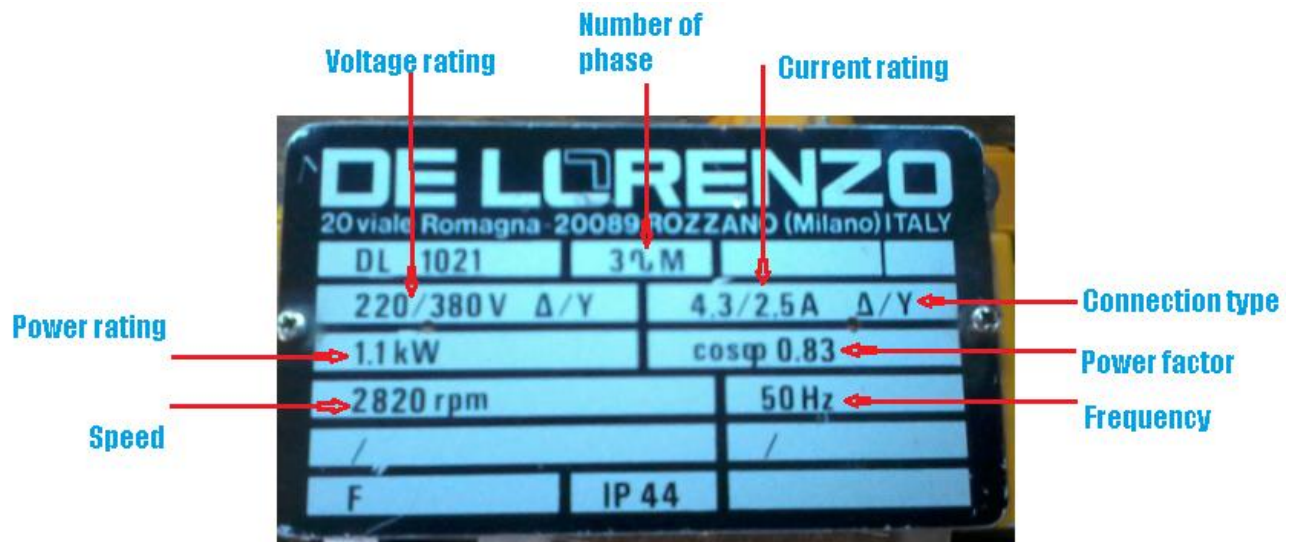

Figure 1.2 Name plate

1.3.2. Internal Data

No. of slots: this data tells the number of slots in which windings formed from group of conductors is accommodated.

No. strands: it stands for number turns in one coil side

Wire size: this data is collected by measuring the diameter of wire and calculating the area of conductor which meets the standard of manufacturing.

Winding form: here the type of winding it may be single layer (concentric, mush or chain) or double layer.

Insulation: the grade of insulation must be identified from the original one.

Coil pitch: the slot difference between two coil sides of one coil.

Pitch factor: the ratio of the voltage induced in a short – pitch winding to the voltage that would be induced if the winding were full pitch.

Connection: here we identify the connection style of group of coils it may be in series, parallel or series-parallel.

Page 14 of 124	Author/Copyright :- AGENA CONSTRUCTION AND INDUSTRIAL COLLEGE	Rewinding Single/Three Phase Induction Machine	Version -1
			August, 2022



AGENA CONSTRUCTION AND INDUSTRIAL COLLEGE

Wire type: it may be mostly copper wire or aluminum rarely.

No. of group: it simply indicates group of coils arranged under one pole for one phase.

In general ac motors are divided into asynchronous (induction) motors and synchronous motors. AC

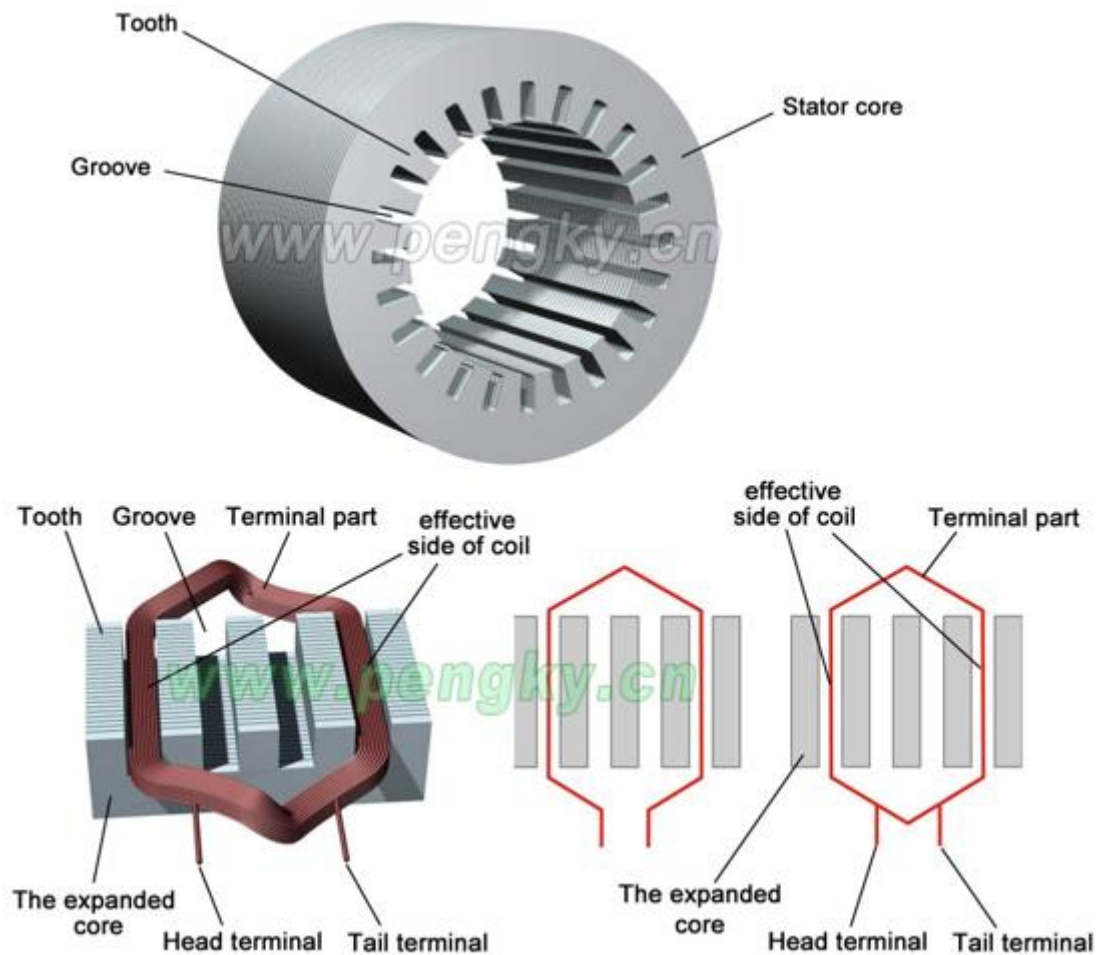

Figure 1.3 Slot structure

Page 15 of 124	Author/Copyright :- AGENA CONSTRUCTION AND INDUSTRIAL COLLEGE	Rewinding Single/Three Phase Induction Machine	Version -1
			August, 2022



AGENA CONSTRUCTION AND INDUSTRIAL COLLEGE

1.3.3. Speed of an Induction Motor

The magnetic field created in the stator rotates at a synchronous speed (NS).

$$N_s = \frac{120f}{P}$$

Where: NS = the synchronous speed of the stator magnetic field in RPM

P = the number of poles on the stator

f = the supply frequency in Hertz

The magnetic field produced in the rotor because of the induced voltage is alternating in nature.

To reduce the relative speed, with respect to the stator, the rotor starts running in the same direction as that of the stator flux and tries to catch up with the rotating flux. However, in practice, the rotor never succeeds in “catching up” to the stator field. The rotor runs slower than the speed of the stator field. This speed is called the actual Speed (N).

The difference between NS and N is called the slip. The slip varies with the load. An increase in load will cause the rotor to slow down or increase slip. A decrease in load will cause the rotor to speed up or decrease slip.

The slip is expressed as a percentage and can be determined with the following formula:

$$S\% = \frac{N_s - N}{N_s} * 100$$

Where: NS = the synchronous speed in RPM

N = the base/actual speed in RPM

Page 16 of 124	Author/Copyright :- AGENA CONSTRUCTION AND INDUSTRIAL COLLEGE	Rewinding Single/Three Phase Induction Machine	Version -1 August, 2022
----------------	---	---	----------------------------



AGENA CONSTRUCTION AND INDUSTRIAL COLLEGE

1.3.4. Number of poles/synchronous

The stator of ac motor is wound for definite number of poles, and the exact number of poles being determined by the requirements of speed.

Greater the number of poles, lesser speed and vice-versa.

$N_s = \frac{120f}{P}$, P stands for number poles. For an induction motor there are arrangements of 2, 4, 6, etc in such a way that half north and half south pole.

A. Rotating field

In a 3-phase induction motor, the three-phase currents i_a , i_b and i_c , each of equal magnitude, but differing in phase by 120° . Each phase current produces a magnetic flux and there is physical 120° shift between each flux. The total flux in the machine is the sum of the three fluxes. The summation of the three ac fluxes results in a rotating flux, which turns with constant speed and has constant amplitude. Such a magnetic flux produced by balanced three phase currents flowing in three-phase windings is called a rotating magnetic flux (RMF). RMF rotates with a constant speed (Synchronous Speed). Existence of a RFM is an essential condition for the operation of an induction motor.

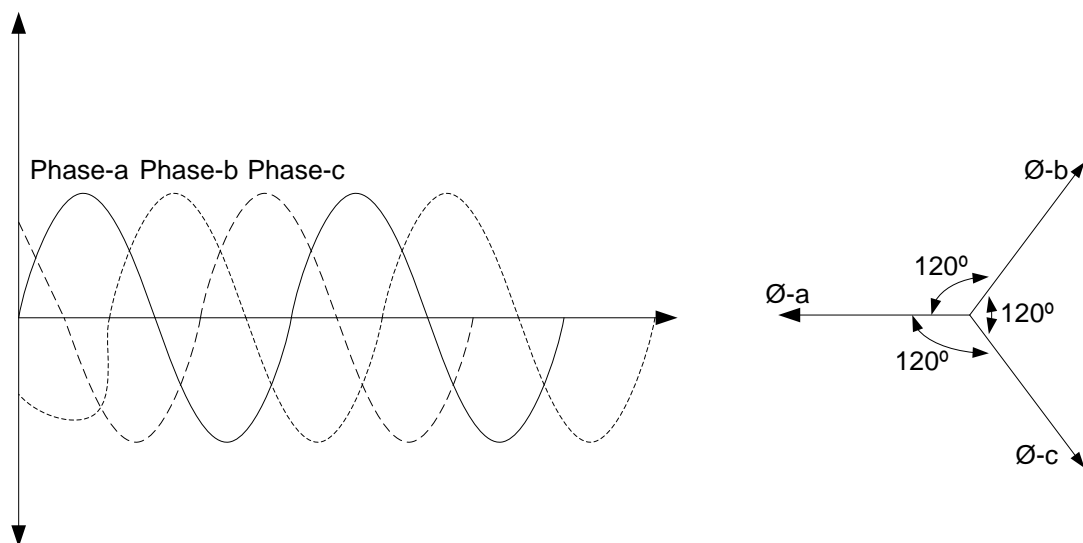

Figure 1.4 Three phase sinusoidal wave

Page 17 of 124	Author/Copyright :- AGENA CONSTRUCTION AND INDUSTRIAL COLLEGE	Rewinding Single/Three Phase Induction Machine	Version -1 August, 2022
----------------	---	---	----------------------------



AGENA CONSTRUCTION AND INDUSTRIAL COLLEGE

If N_s denote the rotating field speed in revolution per second then $N_s = \frac{2f}{p}$ in r.p.s

$$(N_s = \frac{120f}{p} \text{ r.p.m})$$

B. Slip and rotor speed

- The stator magnetic field (rotating magnetic field) rotates at a speed, N_s , the synchronous speed.
- If, N = speed of the rotor, the “slip” S for an induction motor is defined:
$$S = \frac{N_s - N}{N_s} * 100$$
- At stand still which rotor does not rotate, $S = 1$, that is $N = 0$. At synchronous speed, $N = N_s$, $S = 0$.
- The mechanical speed of the rotor, in terms of slip and synchronous speed:
$$N = (1 - S)N_s$$

C. Rotor Speeds

When the stator windings are energized, they set up a rotating magnetic field which is referred to as the **synchronous speed** (N_s). This speed is measured in revolutions per minute (RPM).

NB *This is not the speed at which the motor shaft rotates.*

The speed of the rotating magnetic field depends on

1. The **frequency** of the supply
2. The number of **poles** per winding in the motor

When considering the number of poles in a motor we only need to look at one of the windings. This applies to basic single phase and three phase induction motors. A winding

Page 18 of 124	Author/Copyright :- AGENA CONSTRUCTION AND INDUSTRIAL COLLEGE	Rewinding Single/Three Phase Induction Machine	Version -1 August, 2022
----------------	---	---	----------------------------



AGENA CONSTRUCTION AND INDUSTRIAL COLLEGE

will consist of an even number of poles. These poles are energized in pairs. A large number of poles around the stator will result in a slow speed motor.

A winding cannot have less than two poles (one pair of poles.). This results in the fastest possible motor speed for this type of motor. $(1 + x)^n = 1 + \frac{nx}{1!} + \frac{n(n-1)x^2}{2!} + \dots$

The synchronous speed may be determined by the following formula:

$$N_s = \frac{120f}{P}$$

Where:

Ns	=	The speed of the rotating magnetic field in RPM.
F	=	The frequency of the supply in cycles per second (Hz).
120	=	Converts cycles per second to cycles per minute.
P	=	The number of Pairs of Poles per Winding in the motor.

The stator magnetic field (rotating magnetic field) rotates at a speed, N_s, the synchronous speed.

The synchronous speed for a 2 pole motor operating at 50 Hz is:

$$N_s = \frac{120f}{P}$$

$$N_s = \frac{120 \times 50}{2}$$

$$N_s = 3000 \text{rpm}$$

The synchronous speed in turn determines the rotor speed. As can be seen from the above calculations the greater the number of poles in the motor, the slower the output speed. The rotor speed is between 2.5% and 5.5% slower than the synchronous speed at full load. This is the speed which is given on the motor nameplate. The no load speed of a motor will be slightly higher than the full load speed. A squirrel cage induction motor can be considered to be a constant speed motor, as its speed varies only a small percentage with variations in load.

Page 19 of 124	Author/Copyright :- AGENA CONSTRUCTION AND INDUSTRIAL COLLEGE	Rewinding Single/Three Phase Induction Machine	Version -1 August, 2022
----------------	---	---	----------------------------



AGENA CONSTRUCTION AND INDUSTRIAL COLLEGE

Typical rotor speeds for squirrel cage induction motors are:

- | | | |
|------------|--------------|------------------------------------|
| • 2850 RPM | 2 pole motor | 2 nd most common speed. |
| • 1425 RPM | 4 pole motor | Most common speed. |
| • 950 RPM | 6 pole motor | 3 rd most common speed. |
| • 712 RPM | 8 pole motor | Slow speed applications. |

1.4. Materials for rewinding single/three phase induction machine

1.4.1 Winding insulating materials

The Electrical insulating materials are defined as materials which offer a very large resistance to flow of current, and for that reason they are used to keep the current in its proper path along the conductor. This is evident when we touch an electric machine when it is under operation. We don't receive any electric shocks, because of the insulation. Breakdown of insulation results in short circuiting of the coils, causing electric currents to flow in unintended paths. This may also cause, electric shocks to humans operating the machinery and also damage the machines.

Requirements of a good insulating materials involve physical properties, reliability, cost, availability, adaptability to machining operations etc. Electrical insulation and dielectric materials includes various forms of materials that surround and protect electrical conductors and prevent unwanted current flow, leakage. Electrical specifications include electrical resistivity, dielectric strength, and dielectric constant.

Page 20 of 124	Author/Copyright :- AGENA CONSTRUCTION AND INDUSTRIAL COLLEGE	Rewinding Single/Three Phase Induction Machine	Version -1 August, 2022
----------------	---	---	----------------------------



AGENA CONSTRUCTION AND INDUSTRIAL COLLEGE

Electrical Resistivity: It is the electrical resistance (ohm-cm) to the flow of current through it.

Its value should be very high. Resistivity is the inverse of conductivity.

Dielectric Strength: Dielectric strength is the maximum voltage gradient that the material can withstand before electrical breakdown occurs. This value specified as 'kV/mm' should be very high even for very thin films.

Thus the insulating materials are grouped into different classes Y, A, B, and C with temperature limits of 900°C, 1050°C and 1300°C for the first three classes and no specific limit for C.

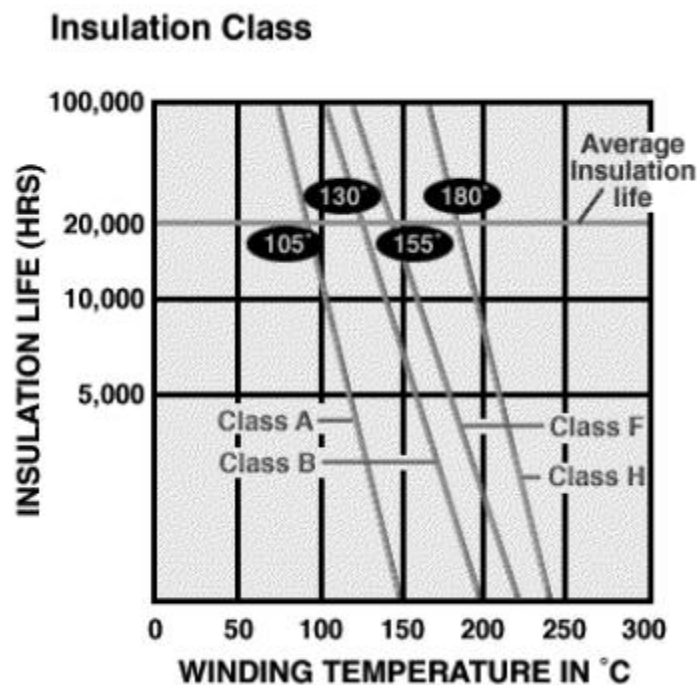

Figure 1.5 Temperature Graph

Page 21 of 124	Author/Copyright :- AGENA CONSTRUCTION AND INDUSTRIAL COLLEGE	Rewinding Single/Three Phase Induction Machine	Version -1
			August, 2022



AGENA CONSTRUCTION AND INDUSTRIAL COLLEGE

Characteristics of a good insulating material: A good insulating material should possess the following characteristics.

Very high insulation resistance.

High dielectric strength.

Low thermal expansion.

Non-inflammable when exposed to arcing.

Resistant to oils or liquids, gas fumes, acids and alkalies.

Should have no deteriorating effect on the material, in contact with it.

Good thermal conductivity.

High mechanical strength

High thermal strength.

Should be resistant to thermal and chemical deterioration.

Should be resistant to moisture absorption.

There are four principal areas where insulation must be applied. They are

Between conductor /coils and earth (phase-to-earth),

Between conductor /coils of different phases (phase-to-phase),

Between turns in a coil (inter-turn) and

Between the coils of the same phase (inter-coil).

Insulation paper: A variety of insulating papers are available specifically designed for insulating electrical circuits. In motors it is used to insulate the slots, in between coils.

Following are the most often used insulating materials: Leatheroid paper, Press pan paper, Manila or hemp paper, Triflexil paper, Asbestos paper, Micanite paper

Insulation cloth: It is inserted between the coils after they are placed in slots. Sometimes it is also used as slot liner. Empire cloth, Asbestos cloth, Glass cloth, Mica cloth, Micanite- cloth are some of the types.

Page 22 of 124	Author/Copyright :- AGENA CONSTRUCTION AND INDUSTRIAL COLLEGE	Rewinding Single/Three Phase Induction Machine	Version -1 August, 2022
----------------	---	---	----------------------------



AGENA CONSTRUCTION AND INDUSTRIAL COLLEGE

Insulating varnishes:

Varnish coating, also called Secondary Insulation, is an important component of the insulation system of an electrical machine. Varnishes, of different types are used in the insulation system of electrical machines for impregnation and finishing applications. Advantages of these coatings are:

- Increased mechanical bonding to the winding wires
- Improved dielectric properties
- Improved thermal conductivity
- Protection to the winding against moisture and chemically corrosive environment.

Method of applying varnish:

- Applying a coating with a paint brush
- Dipping the specimen into varnish
- Vacuum pressure method
- Conveyorised dip method.

Winding wire: is solid wire, which, to allow closer winding when making electromagnetic coils, is insulated only with varnish, rather than the thicker plastic or other insulation commonly used on electrical wire. It is used for the winding of electric motors, transformers, inductors, generators, speaker coils, etc.

Wedge/Bamboo sticks: During running of motor, the coils may be come out from the slots due to centrifugal force. This is avoided by inserting bamboo sticks at the top side of the slots. The sticks are made to size depending on the slot size. Hard trees are used for making these sticks.

Cotton or silk: Cotton is hygroscopic (absorbs moisture) and has low dielectric strength, so it must be impregnated with varnish or wax after winding. Cotton covered wire is extensively used for winding of small magnet coils, armature windings of small and medium sized machines, chokes and transformer coils etc. Silk is more expensive than cotton but takes up less space and is therefore used for windings in fractional horse power machines

Page 23 of 124	Author/Copyright :- AGENA CONSTRUCTION AND INDUSTRIAL COLLEGE	Rewinding Single/Three Phase Induction Machine	Version -1 August, 2022
----------------	---	---	----------------------------



AGENA CONSTRUCTION AND INDUSTRIAL COLLEGE

Silk is less hygroscopic and has a higher dielectric strength than cotton, but like cotton it requires impregnation. The operating temperature of cotton and silk is 100°C and the material may catch fire above this temperature.

Table 1.2 List of consumable materials

1	Enameled copper wire/ magnet wire
2	Drawing scotch
3	Insulation tube
4	Mylar/insulation paper
5	Varnish
6	Wedge/bamboo
7	Insulation tape
8	Oil/grease
9	Insulating oil

1.5. Scope of work in rewinding induction machine

1.5.1. Motor overhauling

- Careful disassembly of the motor, remove old windings.
- Cleaning of stator core & slot suitably with compressed air/ mechanical cleaning / chemical cleaning.
- Hot Spot testing of stator core and re-staggering of the stator core if required.
- Rewinding of stator with good quality material and specified insulation
- Varnishing & drying of winding
- Repair of rotor (stamping only) if required, bearings to be replaced if required, bearing covers to be repaired / replaced as per requirement

Page 24 of 124	Author/Copyright :- AGENA CONSTRUCTION AND INDUSTRIAL COLLEGE	Rewinding Single/Three Phase Induction Machine	Version -1 August, 2022
----------------	---	---	----------------------------



AGENA CONSTRUCTION AND INDUSTRIAL COLLEGE

- Use phase insulation in all three phases. Stator insulation strength must be ensured by measuring R60/R15 and should be more than 1.3. The VVVF drive motors, special varnishing shall be done on the stator windings that shall be carried out by VPI process i.e. dip impregnating coils in Class F moisture protection and finishing varnish by VPI Process and curing the same in Auto control cut off oven.
- Brazed connections to be used instead of crimped ones
- Rewinding of rotor as per requirement
- Healthiness of motor space heater to be ensured
- Final assembly of motor with terminal chambers
- Conduct relevant tests as per Relevant, Latest BIS standards, Prepare test reports and submission with the Purchaser
- Third party inspection, the cost of third party deputation shall be in the scope of Purchaser.
- All kinds of enabling jobs e.g. replacement of minor hardware i.e. circlips, fasteners etc.,
- Replacement of cooling fans (Purchaser Supply), Terminal Blocks (Purchaser Supply) shall be done with prior approval of Purchaser.
- Dynamic balancing of Rotor, bushing, end shield covers, undercutting and metalizing jobs, reconditioning of shafts (at bearing locations) / replacement of shaft
- The motor shall be painted with one coat of red oxide primer and two coats of epoxy paint of original colour followed by proper surface cleaning.

1.5.2. Optional Jobs, Motor Overhauling

- Dynamic balancing of rotor, bushings
- Undercutting work of end shield covers
- Undercutting and metalizing
- Reconditioning of rotor shaft (both end) at bearing location
- Replacement of Rotor shaft
- Replacement of OPGC supplied cooling fan, OPGC supplied terminal Blocks

Page 25 of 124	Author/Copyright :- AGENA CONSTRUCTION AND INDUSTRIAL COLLEGE	Rewinding Single/Three Phase Induction Machine	Version -1 August, 2022
----------------	---	---	----------------------------



AGENA CONSTRUCTION AND INDUSTRIAL COLLEGE

1.5.3. Inspection and testing

- The agency shall conduct all relevant stage inspections tests / Routine Tests, as per relevant BIS standards, but not limiting only to Insulation Resistance, winding resistance test etc. and maintain records of such tests.
- Final Test of the motor e.g. No Load trial run & other characteristics as per relevant BIS standard of the motor shall be done and records of such tests shall be maintained.
- Offer for inspection shall be made to the purchaser with all test records. Inspection of the motor at vendors site by the purchaser's representative / or Third party shall be arranged by the Purchaser at his own cost. Dispatch clearance with / without inspection shall be sole discretion of the purchaser.

1.6. Common terms to motor windings

Pole-pitch: the distance between two adjacent poles. It is equal to the number of armature conductors (or armature slots) per pole. If there are 48 conductors and 4 poles, the pole pitch is $48/4 = 12$.

Conductor: The length of a wire lying in the magnetic field and in which an emf is induced, is called a conductor (or inductor) as, for example, length AB or CD in the following figure.

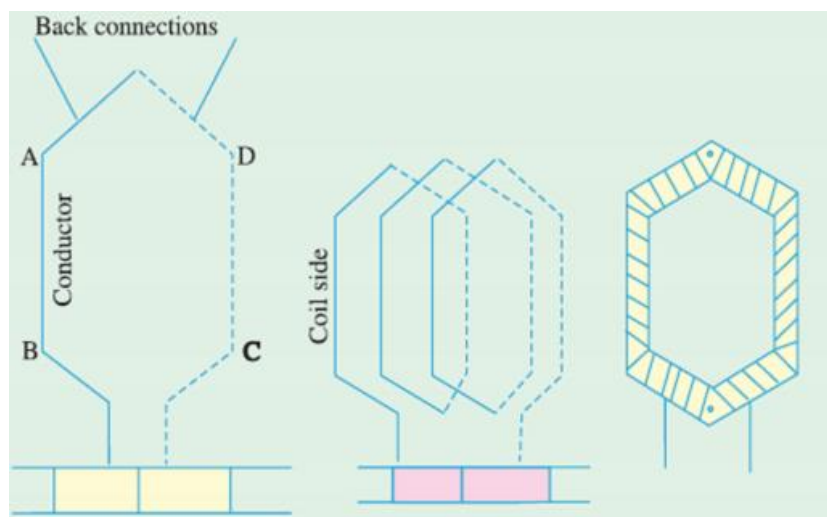

Figure 1.6 Conductors

Page 26 of 124	Author/Copyright :- AGENA CONSTRUCTION AND INDUSTRIAL COLLEGE	Rewinding Single/Three Phase Induction Machine	Version -1 August, 2022
----------------	---	---	----------------------------



AGENA CONSTRUCTION AND INDUSTRIAL COLLEGE

Coil and Winding Element: the two conductors AB and CD along with their end connections constitute one coil of the armature winding. The coil may be single turn coil or multi-turn coil. Multi-turn coil may have many conductors per coil side. The group of wires or conductors constituting a coil side of a multi -turn coil is wrapped with a tape as a unit and is placed in the armature slot. Since the beginning and the end of each coil must be connected to a commutator bar, there are as many commutator bars as coils for both the lap and wave windings. The side of a coil (1-turn or multi-turn) is called a winding element. The number of winding elements is twice the number of coils.

Coil-span or Coil-pitch (YS): It is the distance, measured in terms of armature slots (or armature conductors) between two sides of a coil. If the pole span or coil pitch is equal to the pole pitch. Then winding is called full-pitched. It means that coil span is 180 electrical degrees. In this case, the coil sides lie under opposite poles, hence the induced emfs in them are additive. Therefore, maximum emf is 12 induced in the coil as a whole, it being the sum of the emfs induced in the two coil sides. If the coil span is less than the pole pitch, then the winding is fractional-pitched. In this case, there is a phase difference between the emfs. In the two sides of the coil. Hence, the total emf round the coil which is the vector sum of emfs in the two coil sides is less in this case as compared to that in the first case.

Back Pitch (YB): The distance, measured in terms of the armature conductors, which a coil advances on the back of the armature is called back pitch.

Front Pitch (YF): The number of armature conductors or elements spanned by a coil on the front (or commutator end of an armature) is called the front pitch.

Page 27 of 124	Author/Copyright :- AGENA CONSTRUCTION AND INDUSTRIAL COLLEGE	Rewinding Single/Three Phase Induction Machine	Version -1 August, 2022
----------------	---	---	----------------------------



AGENA CONSTRUCTION AND INDUSTRIAL COLLEGE

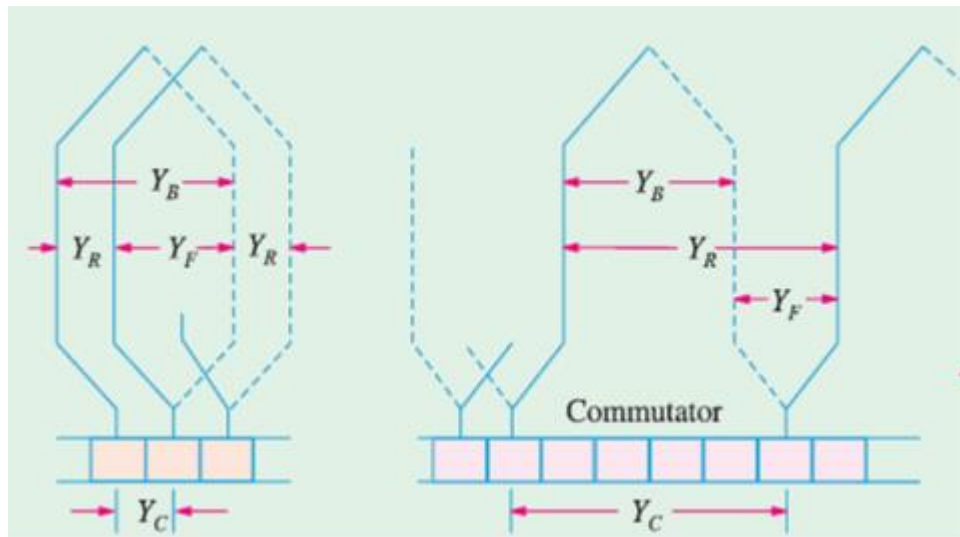

Figure 1.7 Pitch

Resultant Pitch (YR): It is the distance between the beginning of one coil and the beginning of the next coil to which it is connected.

Commutator Pitch (Yc): It is the distance (measured in commutator bars or segments) between the segments to which the two ends of a coil are connected.

Single-layer Winding: It is that winding in which one conductor or one coil side is placed in each armature slot. Such a winding is not much used.

Two/Double-layer Winding: In this type of winding, there are two conductors or coil sides per slot arranged in two layers. Usually, one side of every coil lies in the upper half of one slot and other side lies in the lower half of some other slot. Such windings in which two coil sides occupy each slot are most commonly used for all medium-sized machines. Sometimes 4 or 6 or 8 coil sides are used in each slot in several layers because it is not practicable to have too many slots.

Multiplex Winding: In such windings, there are several sets of completely closed and independent windings. If there is only one set of closed winding, it is called simplex wave winding. If there are two such windings on the same armature, it is called duplex winding and so on. The multiplicity affects a number of parallel paths in the armature. For a given number of armature slots and coils, as the multiplicity increases, the number of parallel paths in the armature increases thereby increasing the current rating but decreasing the voltage rating.

Page 28 of 124	Author/Copyright :- AGENA CONSTRUCTION AND INDUSTRIAL COLLEGE	Rewinding Single/Three Phase Induction Machine	Version -1 August, 2022
----------------	---	---	----------------------------



AGENA CONSTRUCTION AND INDUSTRIAL COLLEGE

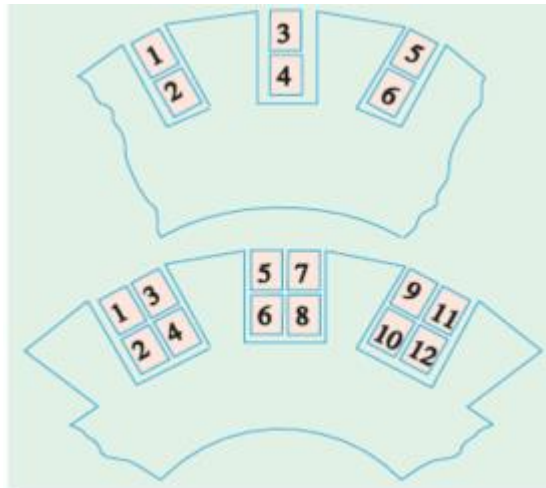

Figure 1.8 winding layer in slot

Lap and Wave Windings: Two types of windings mostly employed are known as Lap Winding and Wave Winding.

Simplex Lap-winding: In lap winding, the finishing end of one coil is connected to a commutator segment and to the starting end of the adjacent coil situated under the same pole and so on, till all the coils have been connected. This type of winding derives its name from the fact it doubles or laps back with its succeeding coils. Following points regarding simplex lap winding should be carefully noted:

- The back and front pitches are odd and of opposite sign. But they cannot be equal. They differ by 2 or.
- Resultant pitch YR is even, $YR = YB - YF = 2$.
- The number of slots for a 2 -layer winding is equal to the number of coils. The number of commutator segments is also the same.
- The number of parallel paths in the armature (A) = P where P the number of poles.
- If $YB > YF$ i.e. $YB = YF + 2$, then we get a progressive or right -handed winding i.e. a winding which progresses in the clockwise direction as seen from the commutator end. In this case, $YC = +1$.

Page 29 of 124	Author/Copyright :- AGENA CONSTRUCTION AND INDUSTRIAL COLLEGE	Rewinding Single/Three Phase Induction Machine	Version -1 August, 2022
----------------	---	---	----------------------------



AGENA CONSTRUCTION AND INDUSTRIAL COLLEGE

- If $YB < YF$ i.e. $YB = YF - 2$, then we get a retrogressive or left-handed winding i.e. one which advances in the anti-clockwise direction when seen from the commutator side. In this case, $YC = -1$.
- $YF = (Z/P - 1)$ and $YB = (Z/P + 1)$ for progressive winding; and $YF = (Z/P + 1)$ and $YB = (Z/P - 1)$ for retrogressive winding.
- Z/P must be even to make the winding possible.
- The total number of brushes is equal to the number of poles.
- The number of armature conductors (connected in series) in any parallel path is Z/P .

• Generated emf $E_g = e.m.f \text{ per one conductor} \times \frac{Z}{P} = e_{av} \times \frac{Z}{P}$

The equivalent armature resistance can be found as follows: Let l = length of each armature conductor; S = cross-section area of the conductor, A = no. of parallel paths in armature= P , R = resistance of one conductor then $R = \frac{\rho l}{S}$,

Resistance of each path $(R_{\text{path}}) = \frac{\rho l Z}{SA}$ There are A paths in parallel, hence the total

• resistance of the armature $(R_a) = \frac{1}{A} \times \frac{\rho l Z}{SA} = \frac{\rho l Z}{SA^2}$

- If I_a is the total armature current, then current per parallel path (or carried by each conductor) is I_a/P .

Simplex Wave Winding: conductor AB is connected to CD lying under S-pole and then to EF under the next N-pole. In this way, the winding progresses, passing successively under every N-pole and S-pole till it returns to a conductor A'B' lying under the original pole.

Because the winding progresses in one direction round the armature in a series of 'waves', it is known as wave winding. If, after passing once round the armature, the winding falls in a slot to the left of its starting point then the winding is said to be retrogressive. If, however, it falls one slot to the right, then it is progressive. Assuming a 2-layer winding and supposing that conductor AB lies in the upper half of the slot, then going once round the armature, the winding ends at A'B' which must be at the upper half of the slot at the left or right.

Page 30 of 124	Author/Copyright :- AGENA CONSTRUCTION AND INDUSTRIAL COLLEGE	Rewinding Single/Three Phase Induction Machine	Version -1 August, 2022
----------------	---	---	----------------------------



AGENA CONSTRUCTION AND INDUSTRIAL COLLEGE

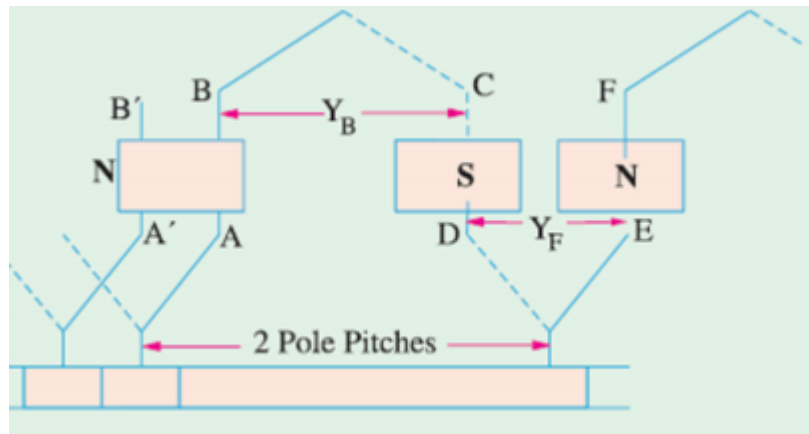

Figure 1.9 Wave winding

Following points regarding simplex wave winding should be carefully noted:

- Average pitch $Y_A = \frac{Y_B + Y_F}{2}$ and $Y_A = \frac{Z \mp 2}{P}$
- Both pitches Y_B and Y_F are odd and of the same sign.
- Resultant pitch $Y_R = Y_F + Y_B$.
- Commutator pitch, $Y_C = Y_A$ (in lap winding $Y_C = \pm 1$). Also, $Y_C = \text{No. of commutator bars} \pm 1 / \text{No. of pair of poles}$.
- The number of coils i.e. N_C can be found from the relation $N_C = (P Y_A \pm 2) / 2$.
- Only two brushes are necessary, though their number may be equal to the number of poles.
- The number of parallel paths through the armature winding is two irrespective of the number of generator poles.
- The generator emf is equal to the emf induced in any one of the two parallel paths. If e_{av} is the emf induced/conductor, then generator emf $(E_g) = e_{av} \cdot Z / 2$.
- The equivalent armature resistance $(R_a) = R_{path} / 2$.
- If I_a is the total armature current, then current carried by each path or conductor is obviously $I_a / 2$ whatever the number of poles.

Page 31 of 124	Author/Copyright :- AGENA CONSTRUCTION AND INDUSTRIAL COLLEGE	Rewinding Single/Three Phase Induction Machine	Version -1
			August, 2022



AGENA CONSTRUCTION AND INDUSTRIAL COLLEGE

Dummy or Idle Coils: These are used with wave-winding and are resorted to when the requirements of the winding are not met by the standard armature punchings available in armature-winding shops. These dummy coils do not influence the electrical characteristics of the winding because they are not connected to the commutator. They are exactly similar to the other coils except that their ends are cut short and taped. They provide mechanical balance for the armature because an armature having some slots without windings would be out of balance mechanically. For example, suppose number of armature slots is 15, each containing 4 sides and the number of poles is 4. For a simplex wave- $YA = (Z \pm 2)/P = (60 \pm 2)/2$ windings, Dummy coils which does not come out to be an integer as required by this winding. However, if we make one coil dummy so that we have 58 active conductors, then $YA = (58 \pm 2)/4 = 14$ or 15 This makes the winding possible.

Uses of Lap and Wave Windings: The advantage of the wave winding is that, for a given number of poles and armature conductors, it gives more emf than the lap winding. Conversely, for the same emf, lap winding would require large number of conductors which will result in higher winding cost and less efficient utilization of space in the armature slots. Hence, wave winding is suitable for small generators especially those meant for 500-600 V circuits. Another advantage is that in wave winding, equalizing connections are not necessary whereas in a lap winding they definitely are. It is so because each of the two paths contains conductors lying under all the poles whereas in lap-wound armatures, each of the P parallel paths contains conductors which lie under one pair of poles. Any inequality of pole fluxes affects two paths equally, hence their induced emfs are equal. In lap-wound armatures, unequal voltages are produced which set up a circulating current that produces sparking at brushes. However, when large currents are required, it is necessary to use lap winding, because it gives more parallel paths. Hence, lap winding is suitable for comparatively low -voltage but high-current generators whereas wave- winding is used for high-voltage, low-current machines.

Page 32 of 124	Author/Copyright :- AGENA CONSTRUCTION AND INDUSTRIAL COLLEGE	Rewinding Single/Three Phase Induction Machine	Version -1 August, 2022
----------------	---	---	----------------------------



AGENA CONSTRUCTION AND INDUSTRIAL COLLEGE

The connection joining the conductors from the end conductors are called the overhang or end winding.

When coil sides forming a coil are spaced exactly one pole pitch apart they are said to be **full pitch**. However, the coil span may be less than a pole pitch in which case the coil described as **short pitched** or chorded (fractional pitch).

Full pitch coil: A coil having a coil span equal to 180° is called a full pitch coil, as shown in Fig. 3.3(a).

Short pitch coil: A coil having a coil span less than 180° by an angle $\hat{\alpha}$, is called a short pitch coil, or fractional pitch coil, as shown in Fig. 3.3 (b). It is also called a chorded coil.

$\hat{\alpha} = 0$ for full pitch winding

$$\text{Also } \hat{\alpha} = \frac{180}{S/p}$$

Where $\hat{\alpha}$ = short pitch angle or an angle less than 180°

$\hat{\alpha}$ = angle between adjacent slots

$x = 1, 2, 3 \dots$ an integer

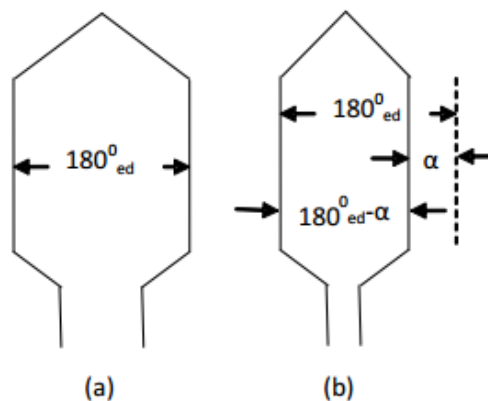

Figure 1.10, (a) full pith, (b) shorted pitch

The most common types of single layer winding are

- a. Concentric winding
- b. Mush winding

Page 33 of 124	Author/Copyright :- AGENA CONSTRUCTION AND INDUSTRIAL COLLEGE	Rewinding Single/Three Phase Induction Machine	Version -1
			August, 2022



AGENA CONSTRUCTION AND INDUSTRIAL COLLEGE

c. Chain winding

Concentric winding

Three phase concentric winding consist of coil groups laid in the slot so that all coils of each group are concentric. In other word the coil with smallest pitch is surrounded by the coil with next larger slot pitch and so on to make up a coil group.

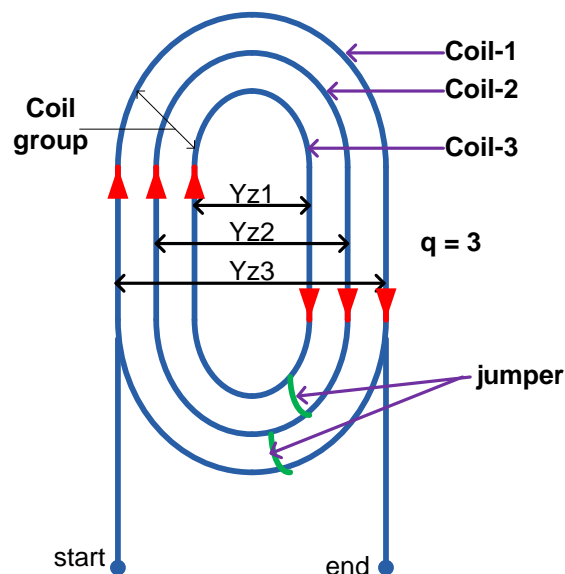

Figure 1.11 Concentric winding

Each coil consists of several turns and the cross over from one coil to the next is indicated by short slanted line called a jumper.

In order to construct the winding diagram the following data must be known.

S = the number of slots in the stator

P = the number of poles

m = the number of phases

Yz = the pitch of the winding

a = the number of parallel paths in the winding; method of connecting the coil groups in phases

Page 34 of 124	Author/Copyright :- AGENA CONSTRUCTION AND INDUSTRIAL COLLEGE	Rewinding Single/Three Phase Induction Machine	Version -1
			August, 2022



AGENA CONSTRUCTION AND INDUSTRIAL COLLEGE

The pitch of winding is determined as:

$$Y_z = S/P$$

The pitch is the distance between the two sides of coil expressed as the difference between the numbers of slots in which the sides lie.

Other important value of the winding of ac machine is the number of slot per phase per pole denoted by letter q.

$$q = \frac{S}{P \cdot m}$$

Number of coil groups (k)

$$k = \frac{3}{2} \cdot P$$

Mush winding

This winding is very commonly used for small induction motors having circular conductors.

This is single layer winding where all the coils have the same span unlike the concentric winding where coils have different spans.

Each coil is wound on a former, making one coil side shorter than the other.

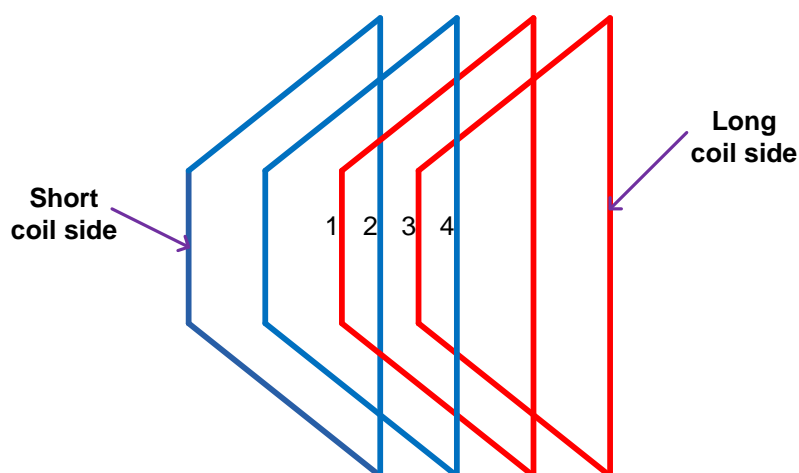

Figure 1.12 Mush winding

Page 35 of 124	Author/Copyright :- AGENA CONSTRUCTION AND INDUSTRIAL COLLEGE	Rewinding Single/Three Phase Induction Machine	Version -1 August, 2022
----------------	---	---	----------------------------



AGENA CONSTRUCTION AND INDUSTRIAL COLLEGE

The short coil sides are placed first and then the long coil side. The long and short coil sides occupy alternate slots.

The following should be kept in mind while designing the mush winding;

1. The coils have a constant span.
2. There is only one coil side per slot and therefore the number of coil sides is equal to the number of slots.
3. There is only one coil group per phase per pole pair and therefore, the maximum number of parallel path per phase is equal the number of half pole pair ($a = P/2$).
4. The coil span should be odd. Thus for a 4 pole 36 slot machine, the coil span equal $36/4 = 9$, while for a four pole 24 slot machine the coil span equal $24/4 = 6$, it should be either 5 or 7.

Chain winding

In all aspects chain winding is similar to that of mush winding except that both coil sides of a coil have equal length and diamond shape, and the coil span may be even or odd.

Connecting coil groups into phases: after the coils are laid into slots the coil groups are connected into phases. The total number of terminal leads is two times number of coil groups. The stator winding must have six terminal leads brought out to the terminal box and this leads being the beginning and ends of the three phase machine. All the remaining leads must be interconnected in the respective phases within the winding.

The number of electrical degrees round the stator however may equal 360° or some multiple of 360° .

$$\gamma = 180^\circ * P$$

The beginning of the second phase which must follow the beginning of the first phase at an interval of 120 electrical degrees will therefore be at a distance of.

$$\lambda = \frac{120^\circ}{\alpha_s}, \text{ where } \alpha_s = \gamma/S$$

Page 36 of 124	Author/Copyright :- AGENA CONSTRUCTION AND INDUSTRIAL COLLEGE	Rewinding Single/Three Phase Induction Machine	Version -1 August, 2022
----------------	---	---	----------------------------



AGENA CONSTRUCTION AND INDUSTRIAL COLLEGE

The coil groups in each phase should be interconnected by joining unlike leads that is start to finish or finish to start.

Complete winding diagram

Given data

$S = 24, P = 4, m = 3, a = 1$ (series winding) and concentric winding.

Soln

$$Y_z = S/P = 24/4 = 6$$

$$k = (3/2) * P = 3/2 * 4 = 6$$

$$k/m = 6/3 = 2 \text{ coil groups/phase}$$

$$q = S/P * m = 24/4 * 3 = 2$$

$$Y_z = \frac{Y_{z1} + Y_{z2}}{2} = 6 \quad Y_{z1} = 5 \text{ and } y_{z2} = 7$$

$$\Upsilon = 180^\circ * P = 180^\circ * 4 = 720^\circ$$

$$\alpha_s = \Upsilon/S = 720^\circ/24 = 30^\circ$$

$$\lambda = 120^\circ/\alpha_s = 120^\circ/30^\circ = 4 \text{ slots}$$

Phase sequence

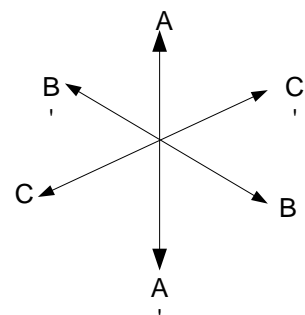
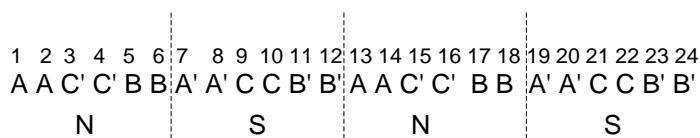

Figure 1.13 Phase sequence

Page 37 of 124	Author/Copyright :- AGENA CONSTRUCTION AND INDUSTRIAL COLLEGE	Rewinding Single/Three Phase Induction Machine	Version -1 August, 2022
----------------	---	---	----------------------------



AGENA CONSTRUCTION AND INDUSTRIAL COLLEGE

Connection diagram

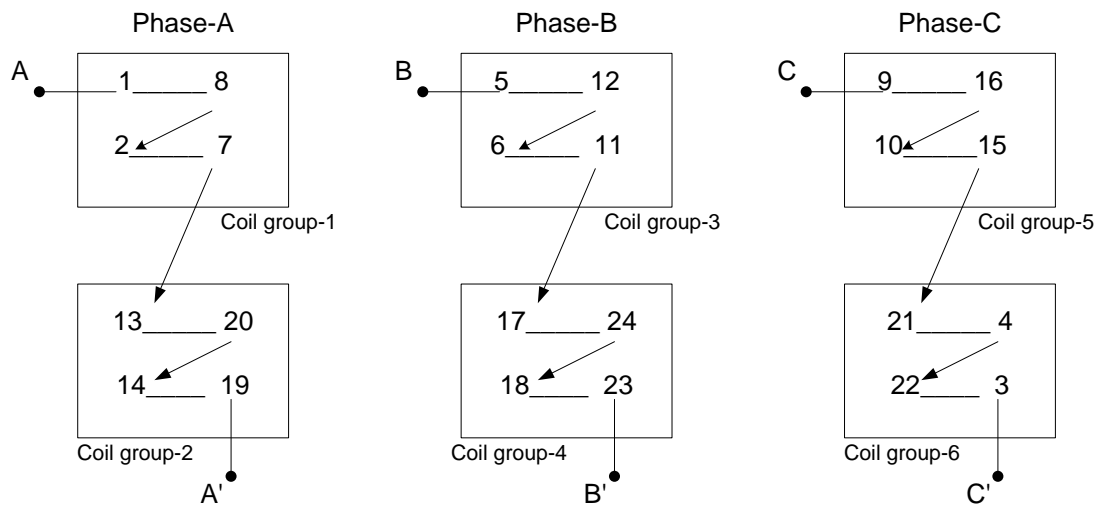
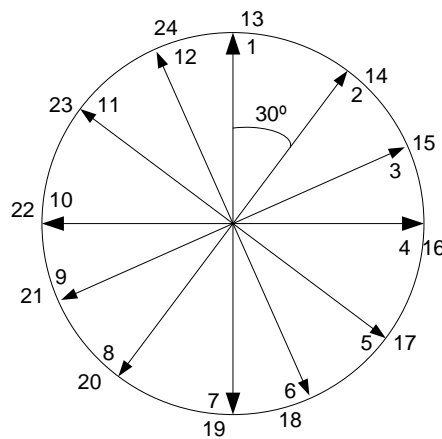

Figure 1.14 connection diagram



Page 38 of 124	Author/Copyright :- AGENA CONSTRUCTION AND INDUSTRIAL COLLEGE	Rewinding Single/Three Phase Induction Machine	Version -1
			August, 2022



AGENA CONSTRUCTION AND INDUSTRIAL COLLEGE

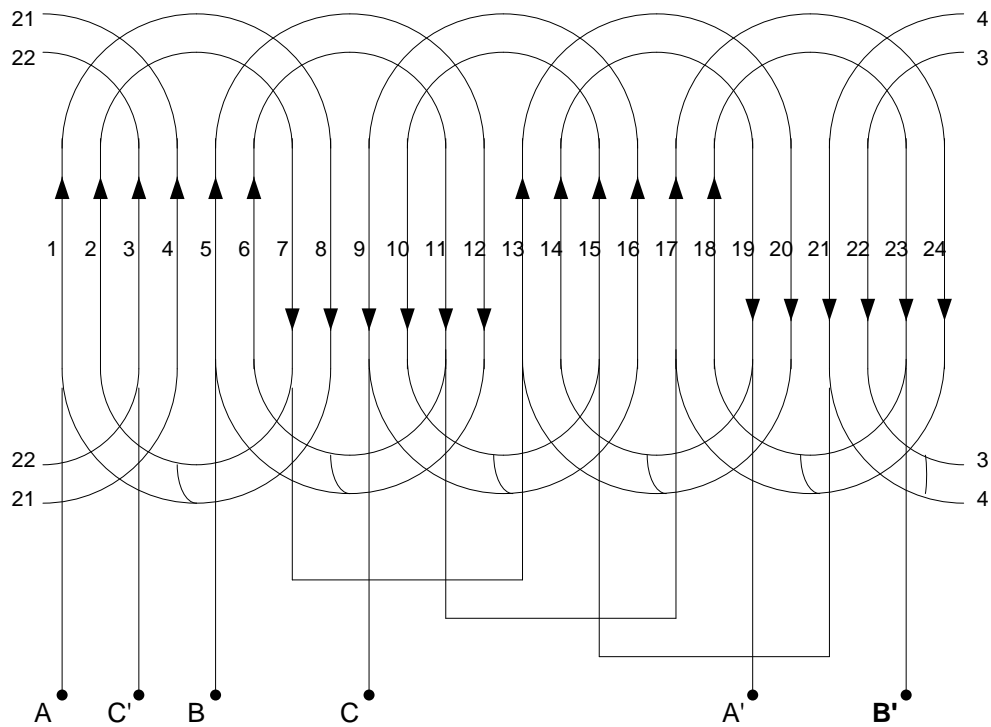

Figure 1.15 Concentric developed winding diagram

Given data

$S = 24, P = 4, m = 3, a = 1$ (series winding) and mush winding.

Soln

$Yz = S/P = 24/4 = 6$, since the coil pitch (span) shouldn't be even take $Yz = 5$.

$$k = (3/2) * P = 3/2 * 4 = 6$$

$$k/m = 6/3 = 2 \text{ coil groups/phase}$$

$$q = \frac{S}{P * m} = 24/4 * 3 = 2$$

$$Y = 180 * P = 180 * 4 = 720^\circ$$

$$\alpha_s = Y/S = 720^\circ/24 = 30^\circ$$

$$\lambda = 120^\circ/\alpha_s = 120^\circ/30^\circ = 4 \text{ slots}$$

Page 39 of 124	Author/Copyright :- AGENA CONSTRUCTION AND INDUSTRIAL COLLEGE	Rewinding Single/Three Phase Induction Machine	Version -1
			August, 2022



AGENA CONSTRUCTION AND INDUSTRIAL COLLEGE

Phase sequence

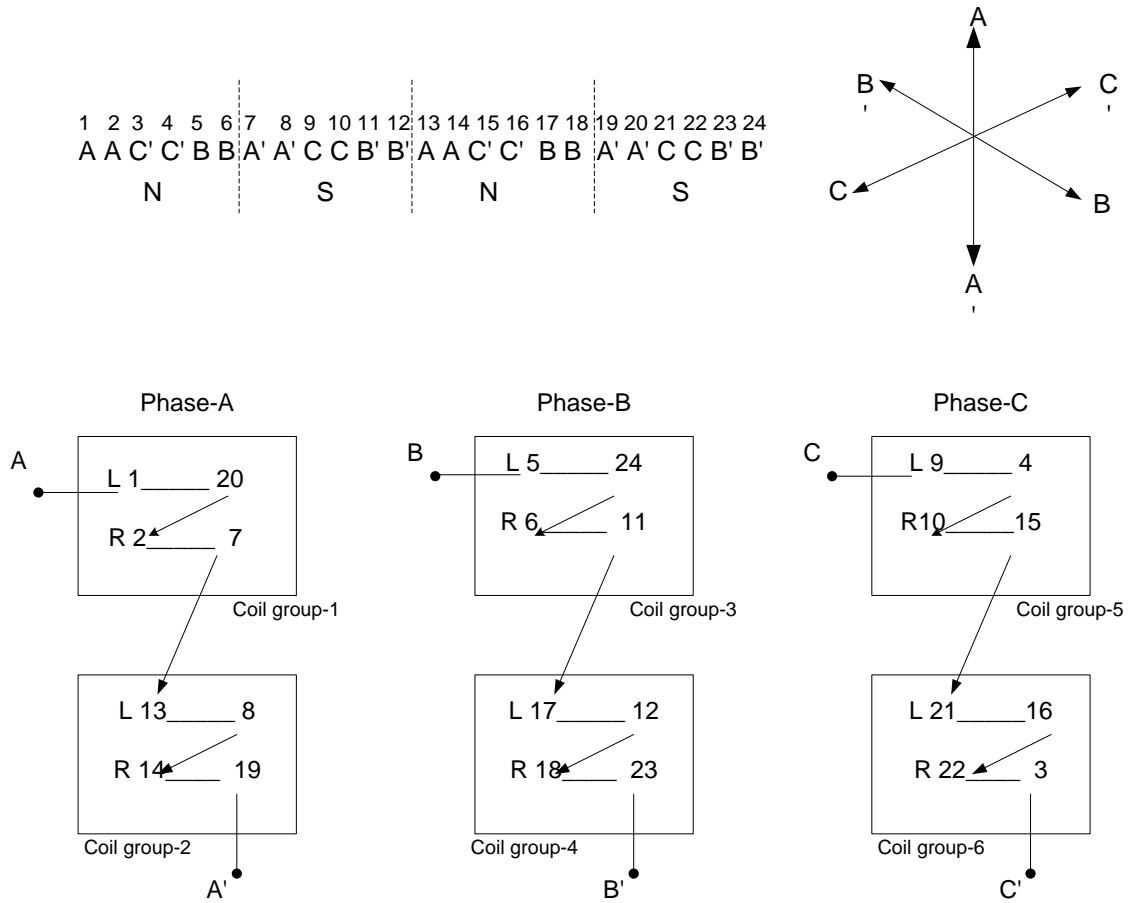

Figure 1.16 Connection diagram



AGENA CONSTRUCTION AND INDUSTRIAL COLLEGE

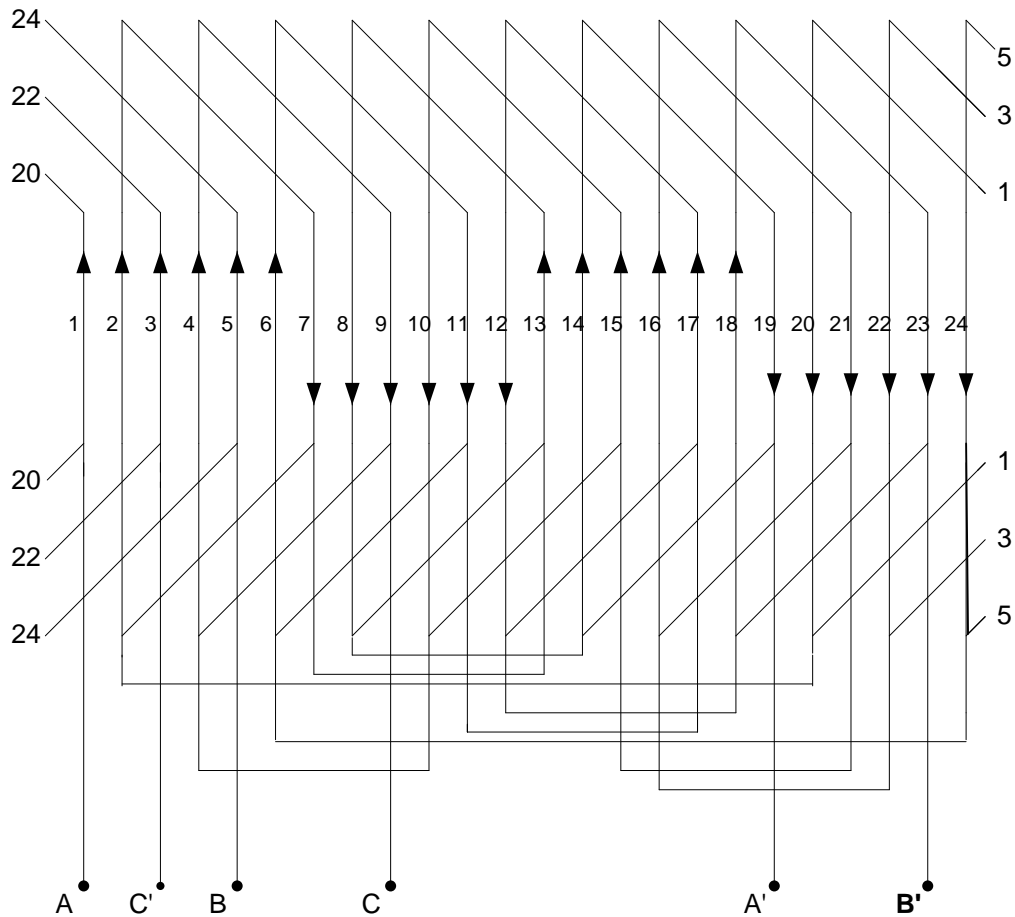

Figure 1.17 Mush developed winding diagram

Given data

$S = 24, P = 4, m = 3, a = 1$ (series winding) and chain winding.

Soln

$$Y_z = S/P = 24/4 = 6$$

$$k = (3/2) * P = 3/2 * 4 = 6$$

$$k/m = 6/3 = 2 \text{ coil groups/phase}$$

$$q = \frac{S}{P * m} = 24/4 * 3 = 2$$

$$\Upsilon = 180^\circ * P = 180^\circ * 4 = 720^\circ$$

Page 41 of 124	Author/Copyright :- AGENA CONSTRUCTION AND INDUSTRIAL COLLEGE	Rewinding Single/Three Phase Induction Machine	Version -1
			August, 2022



AGENA CONSTRUCTION AND INDUSTRIAL COLLEGE

$$\alpha_s = \gamma/S = 720^\circ/24 = 30^\circ$$

$$\lambda = 120^\circ/\alpha_s = 120^\circ/30^\circ = 4 \text{ slots}$$

Phase sequence

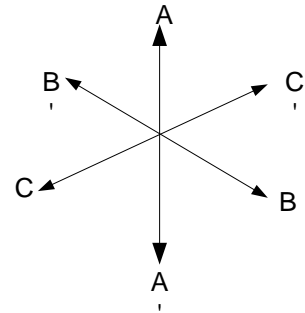
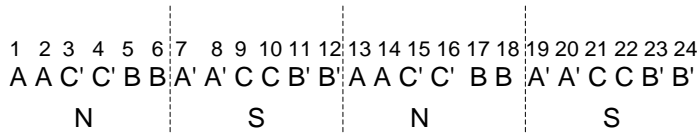

Connection diagram

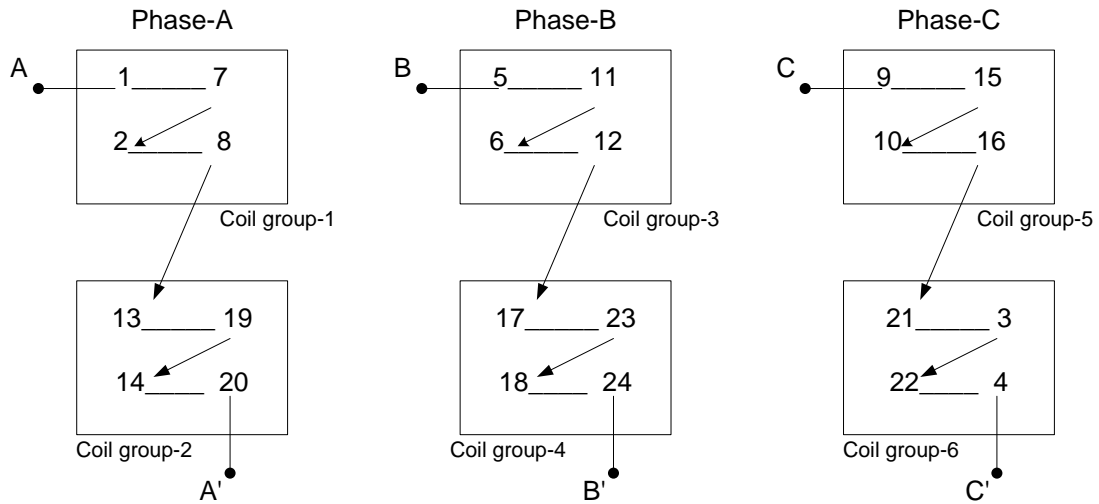

Figure 1.18 Connection diagram

Page 42 of 124	Author/Copyright :- AGENA CONSTRUCTION AND INDUSTRIAL COLLEGE	Rewinding Single/Three Phase Induction Machine	Version -1 August, 2022
----------------	---	---	----------------------------



AGENA CONSTRUCTION AND INDUSTRIAL COLLEGE

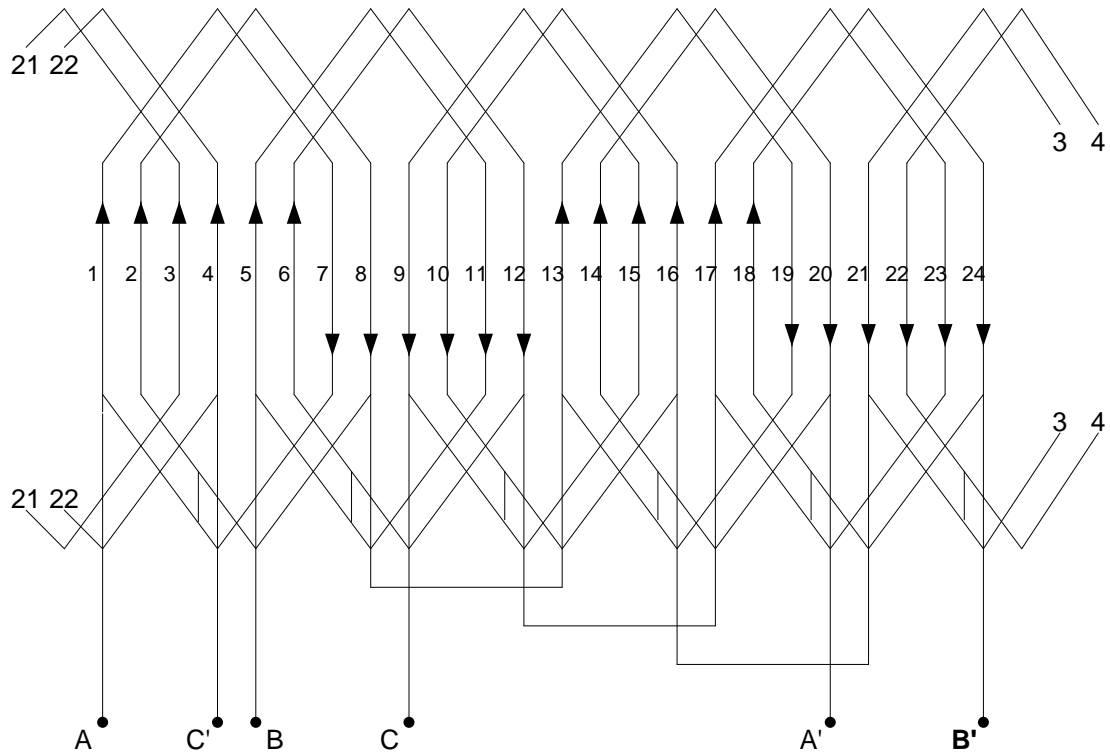
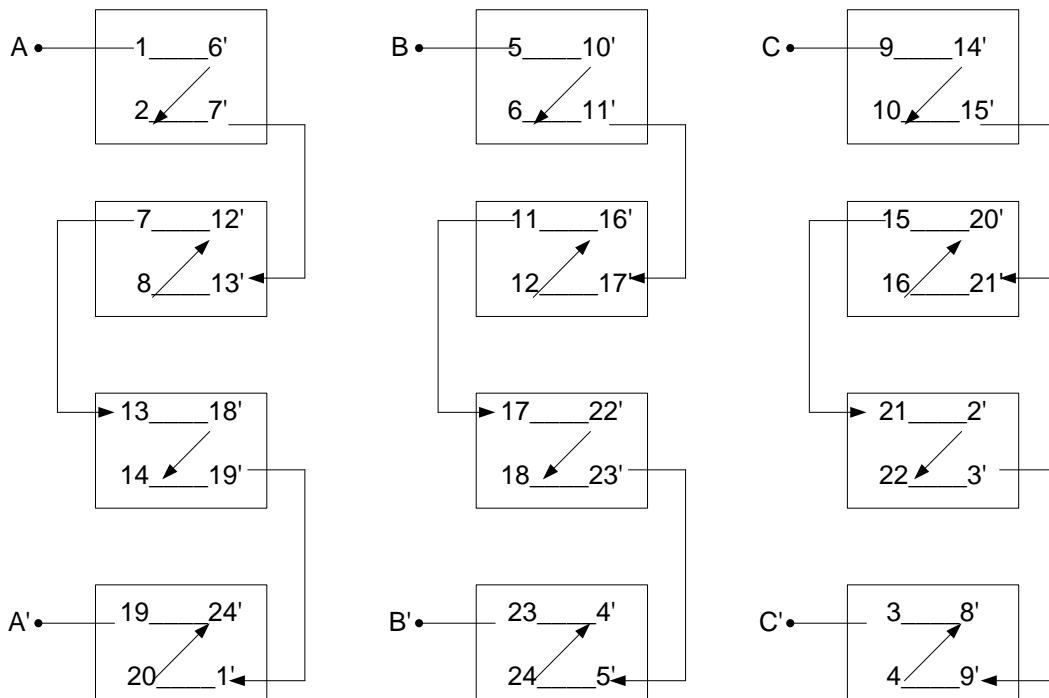

Figure 1.19 Chain developed winding diagram

Winding diagram for three phase wound rotor induction motor (rotor part).

Given Data: $S = 24$, $P = 4$, $m = 3$, $a = 1$ and Double layer winding





AGENA CONSTRUCTION AND INDUSTRIAL COLLEGE

Figure 1.20 Rotor winding

Three finishes of the phases (A', B' and C') are connected together to form star connection and the three start (A, B and C) connection are connected to slip rings which are fixed on shaft of rotor.

Double layer stator winding

Double layer winding differ from single layer winding layer:

- Each slot is occupied by two coil sides and each coil is arranged to form two layer round stator.
- One layer of the winding lies in the bottom half of the slot and the other in the top half of slot.
- In double layer winding, the coil pitch is the distance between the top and bottom sides of coil expressed by the number of slots spanned or by the coil sides occupied by each coil side.
- A coil pitch may be full or fractional. Majority stator winding use fractional pitch because:
 - The amount of copper used in over hang reduced and hence saving on copper.
 - The magnitude of certain harmonic in the e.m.f. is reduced.

Full pitch determined

$$Y_z = S/P$$

Usually the full pitch shorted by one-sixth i.e. for example, if the full pitch is 12, fractional pitch will be 10.

$$q = \frac{S}{P \times m}$$

The number of coils in double layer winding is equal to the number of slots and the number of coil groups per phase is equal to the number of poles.

$$k = 3P$$

Rules for double layer winding:

Page 44 of 124	Author/Copyright :- AGENA CONSTRUCTION AND INDUSTRIAL COLLEGE	Rewinding Single/Three Phase Induction Machine	Version -1 August, 2022
----------------	---	---	----------------------------



AGENA CONSTRUCTION AND INDUSTRIAL COLLEGE

The coil groups should be connected to each other by joining the leads of like polarity that is finish of one group to finish of the next group and the start of one group to the start of the next group.

Given data: $S = 24$, $P = 4$, $m = 3$, $a = 1$

Soln

$$Y_z = S/P = 24/4 = 6, \text{ shorted by } 1/6(Y_z) \text{ and } = Y_z - 1/6(Y_z) = 6 - 1/6(6) = 5$$

$$q = \frac{S}{P \cdot m} = 24/4 \cdot 3 = 2$$

$$k = 3 \cdot P = 3 \cdot 4 = 12$$

$$k/3 = 12/3 = 4$$

$$\Upsilon = 180^\circ \cdot P = 180^\circ \cdot 4 = 720^\circ$$

$$\alpha_s = \Upsilon/S = 720^\circ/24 = 30^\circ$$

$$\lambda = 120^\circ/\alpha_s = 120^\circ/30^\circ = 4 \text{ slots}$$

Phase sequence

1 2 3 4 5 6 7 8 9 10 11 12 13 14 15 16 17 18 19 20 21 22 23 24

A A C C B B A A C C B B A A C C B B A A C C B B

Page 45 of 124	Author/Copyright :- AGENA CONSTRUCTION AND INDUSTRIAL COLLEGE	Rewinding Single/Three Phase Induction Machine	Version -1 August, 2022
----------------	---	---	----------------------------



AGENA CONSTRUCTION AND INDUSTRIAL COLLEGE

Connection diagram

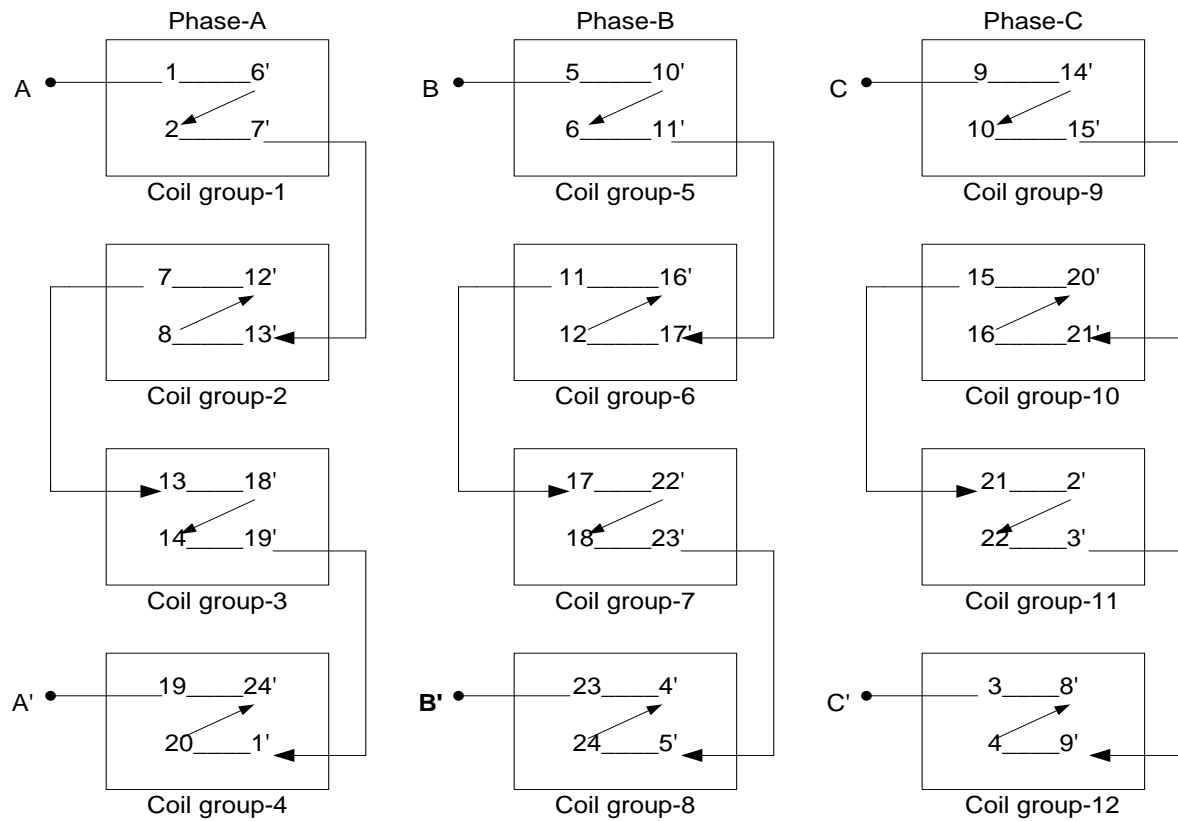

Figure 1.21 Connection diagram double layer



AGENA CONSTRUCTION AND INDUSTRIAL COLLEGE

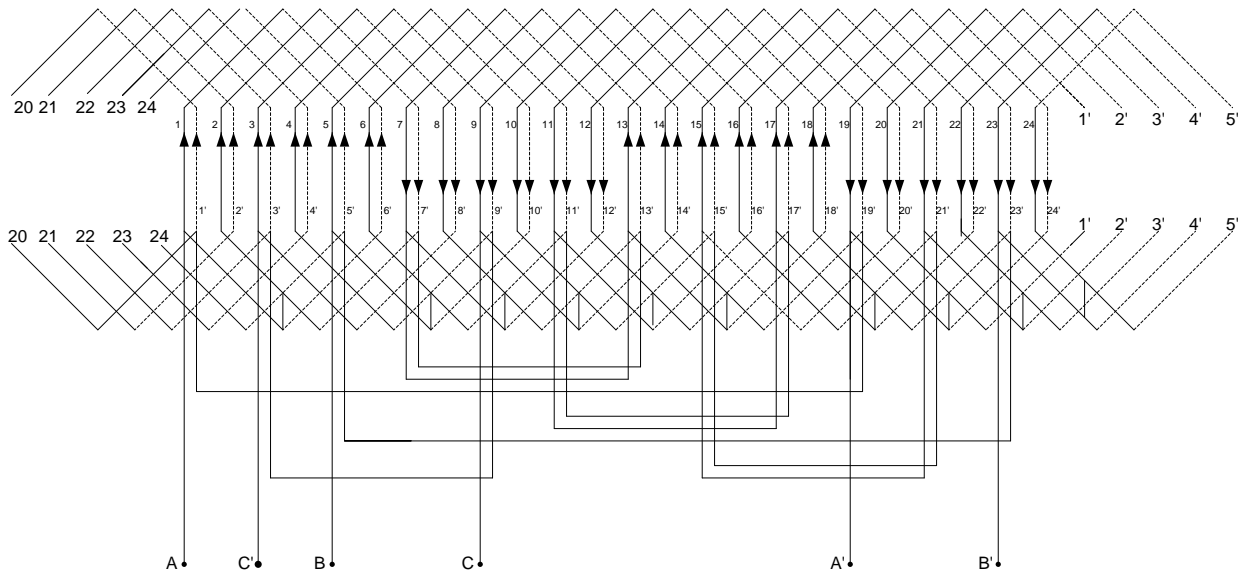

Figure 1.19 Double developed winding diagram

Significance of the number of parallel path (a)

In machine whose phase must carry large currents the coil groups are connected in parallel than in series. The parallel connection should be made so that direction of the current through the coil groups and the pole polarity are exactly the same as in the series connection.

In double layer winding the maximum possible number of parallel branch is equal to the number of poles ($a_{max} = P$).

Methods of connecting coil groups for machine which has four poles:

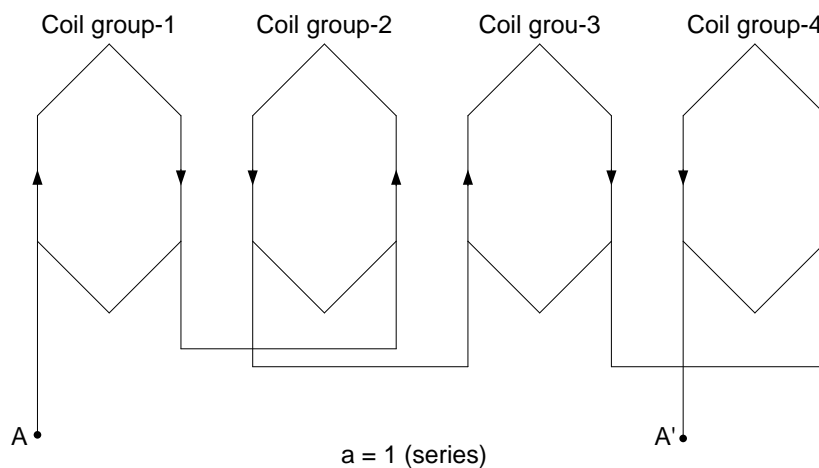

Page 47 of 124	Author/Copyright :- AGENA CONSTRUCTION AND INDUSTRIAL COLLEGE	Rewinding Single/Three Phase Induction Machine	Version -1
			August, 2022



AGENA CONSTRUCTION AND INDUSTRIAL COLLEGE

Figure 1.22 series coil group

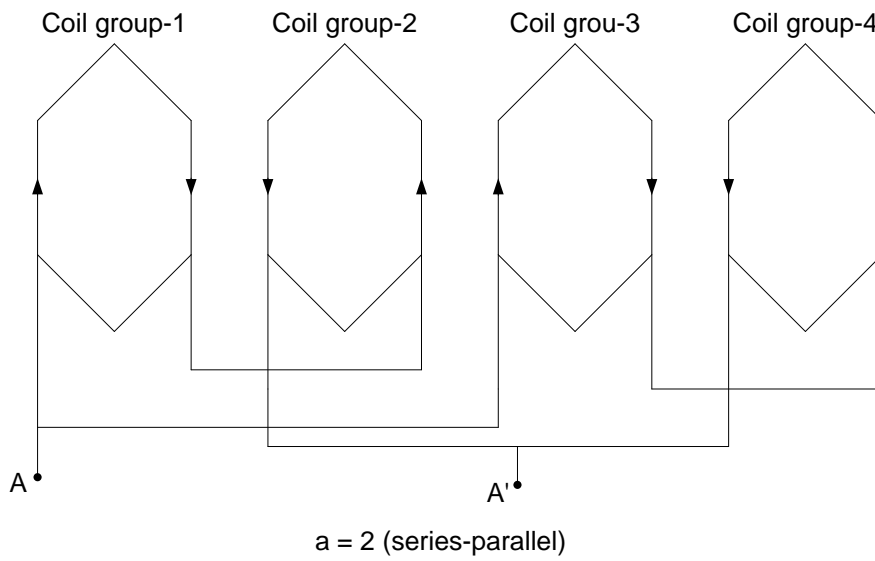

Figure 1.23 Parallel coil group

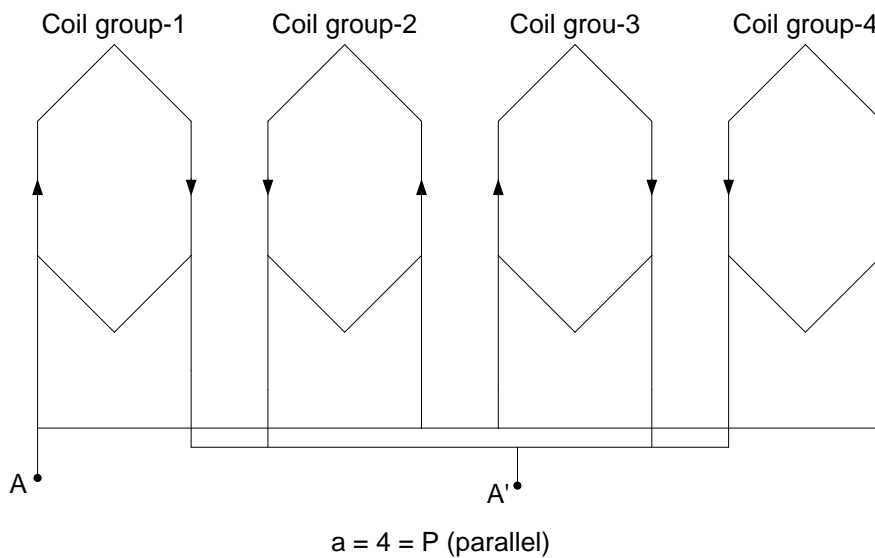

Figure 1.24 series-parallel coil group

Page 48 of 124	Author/Copyright :- AGENA CONSTRUCTION AND INDUSTRIAL COLLEGE	Rewinding Single/Three Phase Induction Machine	Version -1
			August, 2022



AGENA CONSTRUCTION AND INDUSTRIAL COLLEGE

Fractional slot winding

The number of slots per pole per phase (q) is not always an integer. Sometimes we face winding in which the slots per pole per phase are expressed as a whole number plus a fraction.

In induction motors such case usually arise when the stator with the same number of slots are wound for more than one number of poles. For a given number of slots in the stator, the slot per pole per phase in the winding will turn out to the whole number and in the other winding a fractional number.

An induction motor with $S = 36$ is wound for 6 pole, such that a motor will have a speed near to 1000 r.p.m. and $q = \frac{S}{P \times m} = 36/6 \times 3 = 2$

Assume that this the same stator must be rewound for lower speed of 750r.p.m. i.e. for 8 poles.

$$q = 36/8 \times 3 = 1 \frac{1}{2}$$

The fractional slot winding differs from the integral slot winding in that it must be composed of coil groups with different number of coils in each phase must occupy the same number of slots, otherwise the winding would be unbalanced. Usually the fractional slot winding is combination of two types of coil groups.

One in which the number of coils in the group is equal to the integer part of the number of slot per pole per phase. The other in which the number of coil is one greater than in the first type.

For example, if the number of slots per pole per phase is 2.5, the winding will be built up of alternating coil groups containing two and three coils each, every two coil groups being followed by a three coil groups.

A simple combination such as that given in the above example can only be obtained when the fractional part is equal to $\frac{1}{2}$. (AACCCBBAAACCCBBB)

With some other fractional the coil groups become more difficult to combine. Sometimes the fractional of slots per pole per phase is expressed as in improper fraction $q = c/d$ in the above example $c = 5$ and $d = 2$.

Page 49 of 124	Author/Copyright :- AGENA CONSTRUCTION AND INDUSTRIAL COLLEGE	Rewinding Single/Three Phase Induction Machine	Version -1 August, 2022
----------------	---	---	----------------------------



AGENA CONSTRUCTION AND INDUSTRIAL COLLEGE

To obtain a balanced of symmetrical winding it is necessary that $\frac{S}{t+m}$ be equal to whole number.

Where; S = the number of slots

t = the largest common factor of S and P

m = number of phase

The coil groups in a fractional slot winding are easily arranged with the aid of the table as shown below.

Develop the winding diagram for the double layer winding with the following data.

S = 27, P = 6, m = 3, a = 1

Symmetry of the winding can be checked by:

$$\frac{S}{t+m} = 27/3*3 = 3$$

$$q = \frac{S}{P*m} = 27/6*3 = 3/2 \text{ where } c = 3 \text{ and } d = 2$$

Table 1.3 slot distribution 27

poles	Phase-A			Phase-C			Phase-B		
N	1		2		3		4		5
S		6		7		8		9	
N	10		11		12		13		14
S		15		16		17		18	
N	19		20		21		22		23
S		24		25		26		27	

k = 3*P = 3*6 = 18: 9 coil groups with 1 coil and 9 coil groups with 2 coils.

Page 50 of 124	Author/Copyright :- AGENA CONSTRUCTION AND INDUSTRIAL COLLEGE	Rewinding Single/Three Phase Induction Machine	Version -1 August, 2022
----------------	---	---	----------------------------



AGENA CONSTRUCTION AND INDUSTRIAL COLLEGE

The table are filled with number of slot at interval of d . where d is the denominator of the fraction expressing the number of slots per pole per phase (q).

Phase sequence

1 2 3 4 5 6 7 8 9 10 11 12 13 14 15 16 17 18 19 20 21 22 23 24 25 26 27

A A C B B A C C B A A C B B A C C B A A C B B A C C B

$$Yz = S/P = 27/6 = 4.5 \text{ take } Yz = 4$$

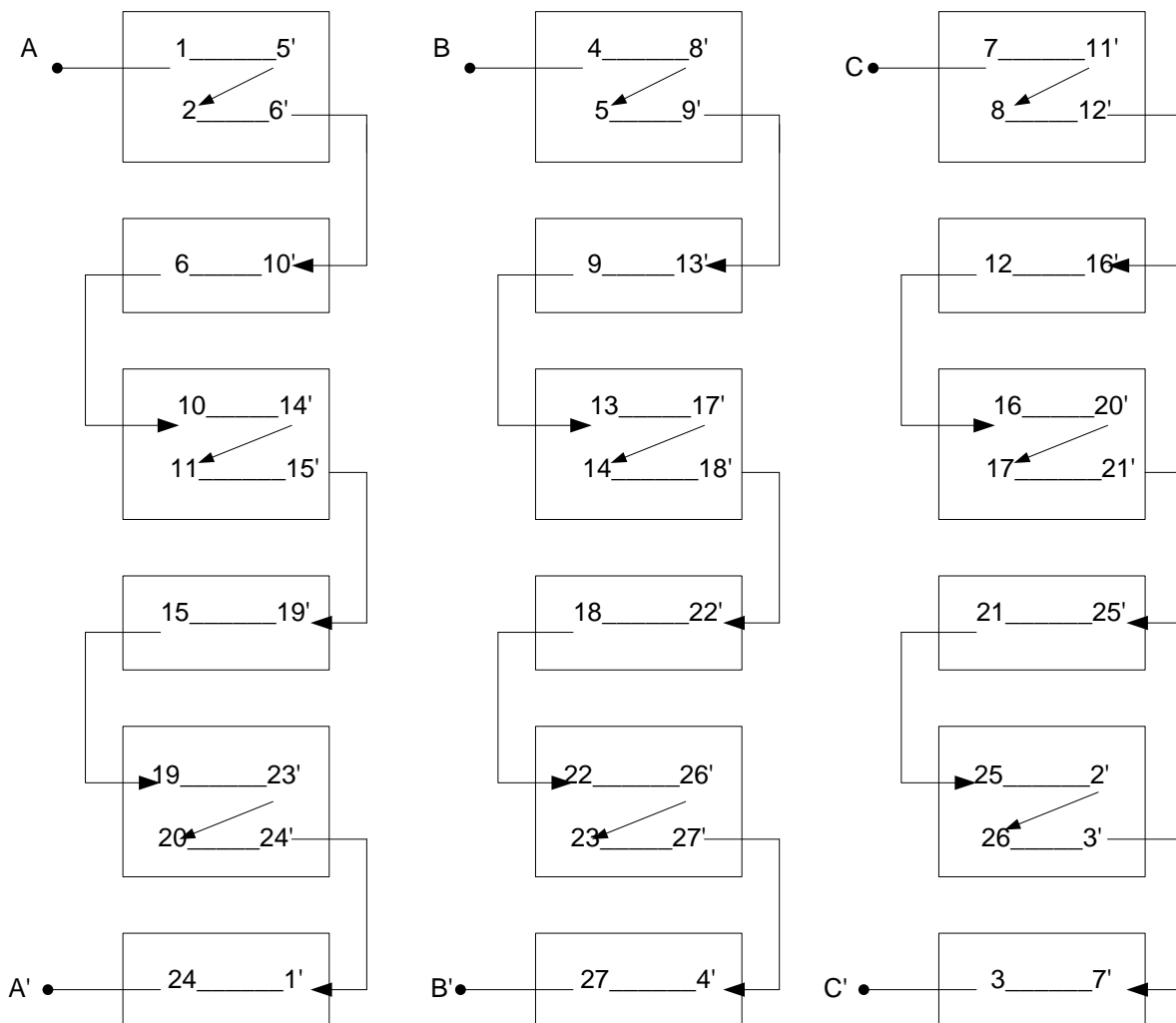

Figure 1.25 Connection diagram

Page 51 of 124	Author/Copyright :- AGENA CONSTRUCTION AND INDUSTRIAL COLLEGE	Rewinding Single/Three Phase Induction Machine	Version -1 August, 2022
----------------	---	---	----------------------------



AGENA CONSTRUCTION AND INDUSTRIAL COLLEGE

Given Data 2: A winding has the following data and construct connection diagram

$$S = 84, P = 20, m = 3$$

$$\frac{S}{t \cdot m} = 84/3 \cdot 4 = 7 \text{ it is symmetry: where } t = 4 \text{ greater common factor of } 20 \text{ and } 84.$$

$$q = \frac{S}{P \cdot m} = 84/20 \cdot 3 = 7/5, c = 7 \text{ and } d = 5$$

Table 1.4 slot distribution 84

poles	Phase-A						Phase-C						Phase-B					
N	1				2					3				4				5
S				6					7				8					9
N			10					11				12					13	
S			14				15				16					17		
N		18				19				20				21				
S	22				23				24				25					26
N				27					28				29					30
S																		

1 2 3 4 5 6 7 8 9 10 11 12 13 14 15 16 17 18 19 20 21 | 22 23 24 25 26 27
 AACBBACBBAC C BAC CB AA CB | AA CB B A

24 coil groups with 2 coil (6*4) and 36 coil groups with 1 coil (9*4): 24*2 + 36 = 84 coils.



AGENA CONSTRUCTION AND INDUSTRIAL COLLEGE

Table 1.5 Coil group sequence

Slot per pole per phase (q)	Coil group sequence
$1\frac{1}{2}$	(2-1), (2-1).....
$1\frac{1}{4}$	(2-1-1-1), (2-1-1-1).....
$1\frac{3}{4}$	(2-2-2-1), (2-2-2-1).....
$1\frac{1}{5}$	(2-1-1-1-1), (2-1-1-1-1).....
$1\frac{2}{5}$	(1-1-2-1-2), (1-1-2-1-2).....
$1\frac{3}{5}$	(2-2-1-2-1), (2-2-1-2-1).....
$2\frac{1}{2}$	(3-2), (3-2).....
$3\frac{1}{4}$	(4-3-3-3), (4-3-3-3).....
$4\frac{1}{5}$	(5-4-4-4-4), (5-4-4-4-4).....



AGENA CONSTRUCTION AND INDUSTRIAL COLLEGE

--	--

Developed winding diagram of single phase motors

As we know single phase motor has two windings: main winding and auxiliary winding.

The main winding coils (made with coarse magnetic wire having a low resistance and a high inductive reactance) will produce a lagging phase current with respect to the source voltage.

The auxiliary winding coils (made with finer magnetic wire having a high resistance and a low inductive reactance) will produce a current in phase with the source voltage.

Both main and auxiliary winding of single phase is constructed with concentric coils of different dimensions.

Number of coil groups (k) is equal to number of poles for both auxiliary and main windings.

$k = P$, where P is number of poles in which the stator is wound.

In order to develop complete winding diagram of ac motor we have to collect data like:

- Number of slots (S)
- Number of poles (P)
- Number phase (m)
- Number of parallel path (a)

Example: $S = 24$, $P = 4$, $m = 1$

16 slots will be occupied with the running winding and 8 slots will be occupied with the starting winding. The number of slots per pole per phase for running winding is 2 and 1 for starting winding.

Page 54 of 124	Author/Copyright :- AGENA CONSTRUCTION AND INDUSTRIAL COLLEGE	Rewinding Single/Three Phase Induction Machine	Version -1
			August, 2022



AGENA CONSTRUCTION AND INDUSTRIAL COLLEGE

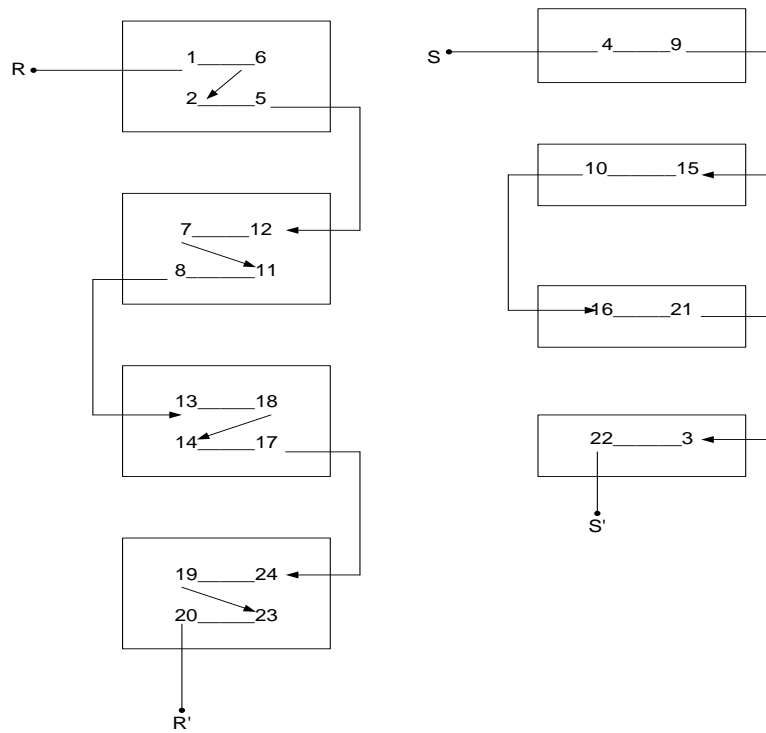

1.26 single phase connection diagram

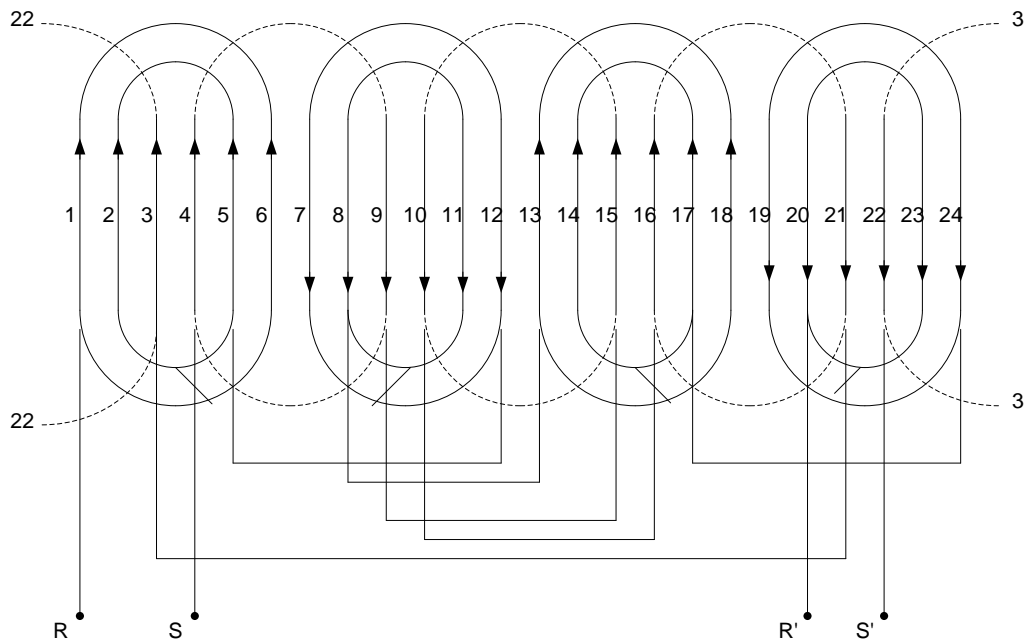

Figure 1.27 single phase developed winding diagram

Page 55 of 124	Author/Copyright :- AGENA CONSTRUCTION AND INDUSTRIAL COLLEGE	Rewinding Single/Three Phase Induction Machine	Version -1
			August, 2022



AGENA CONSTRUCTION AND INDUSTRIAL COLLEGE

Given : $S = 36$ $P = 4$, $m = 1$

32 slots will be occupied with the running winding and 24 slots will be occupied with the starting winding. The number of slots per pole per phase for running winding is 4 and 3 for starting winding.

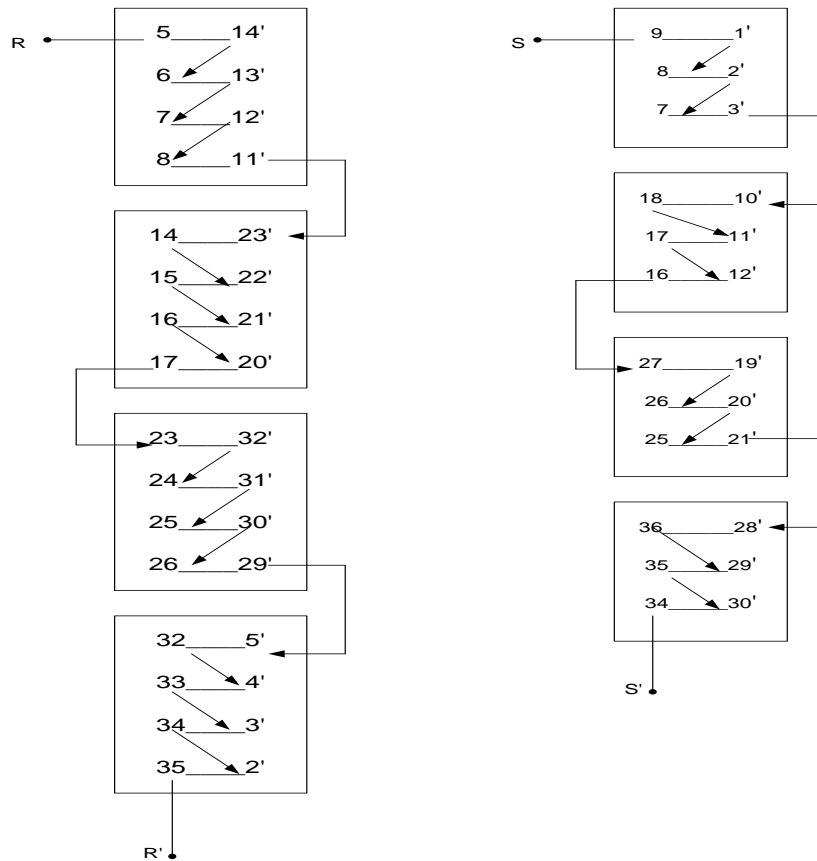

Figure 1.28 connection diagram

Page 56 of 124	Author/Copyright :- AGENA CONSTRUCTION AND INDUSTRIAL COLLEGE	Rewinding Single/Three Phase Induction Machine	Version -1
			August, 2022



AGENA CONSTRUCTION AND INDUSTRIAL COLLEGE

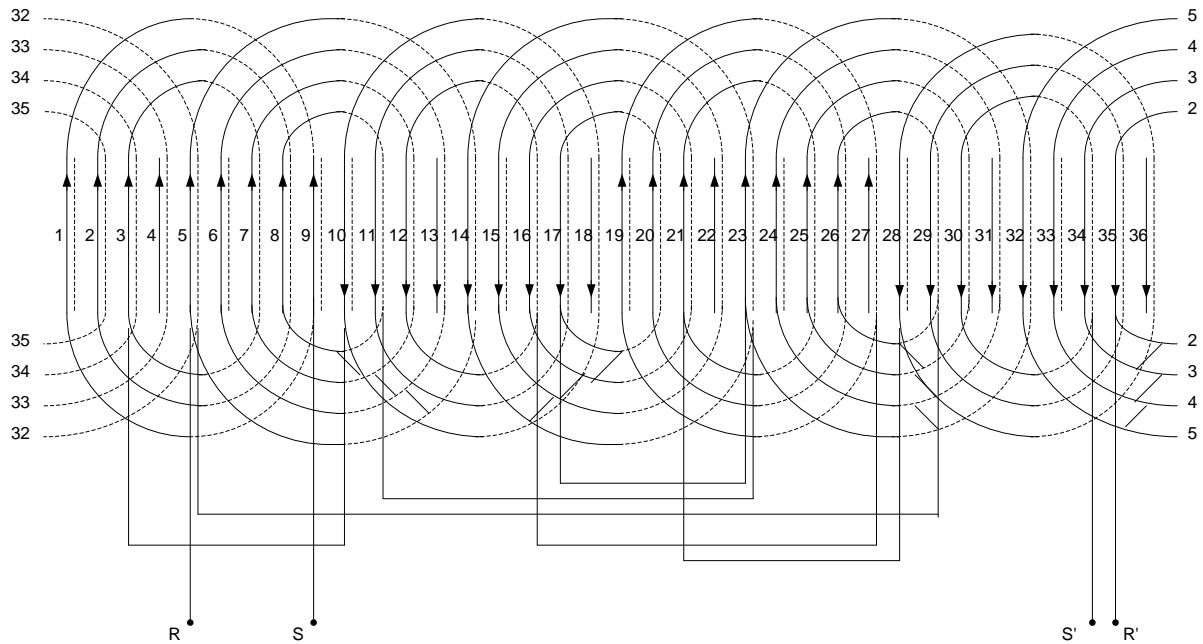

Figure 1.29 single phase developed winding diagram

We may find coils with different number of turns in a coil group to reduce harmonic fluxes which gives rise to certain unwanted effects like noise, vibration and uneven accelerating torque.

N.B. For single phase motor rewinding, tracing from the original/defective one is more advisable and effective than simply developing the diagram as of three phase motor.

1.7. Application of testing techniques to collected data

1.7.1. Testing a Three-Phase Induction Motor

Visual Tests

- Check that motor frame is mechanically sound.
- Remove terminal cover plate and check for ingress of foreign material, moisture etc.
- Check for signs of overheating, arcing or burning.
- Check ventilation is clear.

Page 57 of 124	Author/Copyright :- AGENA CONSTRUCTION AND INDUSTRIAL COLLEGE	Rewinding Single/Three Phase Induction Machine	Version -1 August, 2022
----------------	---	---	----------------------------



AGENA CONSTRUCTION AND INDUSTRIAL COLLEGE

Electrical Tests

- Identify windings using a continuity tester.
- Measure the resistance of the windings (3 identical readings).
- Measure the insulation resistance between each winding and between windings and frame.

Mechanical Tests

- Check that the rotor is free to rotate and does so smoothly/quietly.
- Check that motor interior is free of dirt, dust, water and oil.
- Check for play in bearings.

Tests when Running

- Check run currents (If un even check voltage at motor terminals).
- Check speed of motor at no load and full load.
- Check vibration levels and noise levels.
- Check for temperature hot spots.

1.7.2. Testing of Three-Phase Stator windings

Resistance

Test

This test is carried out on an isolated motor, to check the resistance of the stator windings. It is necessary to make an accurate measurement, so allow reading ohmmeter or a high-resolution digital multi meter should be used.

Step1: Isolate the motor electrically, and if necessary, mechanically.

Step2: Identify the way the motor terminal block is connected.

- **Star connected.** Make a careful note of how the three supply cables are connected so as to avoid errors when re-connecting. Two links connect U2-V2-W2. Remove the links

Page 58 of 124	Author/Copyright :- AGENA CONSTRUCTION AND INDUSTRIAL COLLEGE	Rewinding Single/Three Phase Induction Machine	Version -1 August, 2022
----------------	---	---	----------------------------



AGENA CONSTRUCTION AND INDUSTRIAL COLLEGE

and the supply cables before carrying out the test. Disconnecting the cables ensures that there are no parallel paths via any control equipment, which would lead to false readings being obtained.

- **Delta connected.** Make a care full note of how the three supply cables are connected so as to avoid errors when re-connecting. Three links connect U1 to W2, V1 to U2, and W1 to V2; Remove the links and the supply cables before carrying out the test .Disconnecting the cables ensures that there are no parallel paths via any control equipment, which would lead to false readings being obtained.
- **Star-Delta connected.** Make a care full note of how the six supply cables are connected so as to avoid errors when re-connecting. It is required that all conductors be disconnected from the terminal block during the test. Disconnecting the supply cables ensures that there are no parallel paths via any control equipment, which would lead to false readings being obtained

Step3: Identify the stator windings- usually labeled U1-U2, V1-V2, and W1-W2. Step4: Measure and record the resistance of each winding.

If there is any appreciable difference between one winding and the other two, this indicates a fault condition. If one winding resistance is higher than the other two, this indicates that a high resistance fault is developing possibly due to a poor quality solder joint. An infinite resistance indicates an open circuit (or break) in the winding.

If the resistance of one winding is lower than the other two, this indicates that the winding is becoming short-circuited. This is possibly due to an inter-turns short circuit on that winding. It is usually the result of the winding overheating, which damages the insulation (shellac / varnish), or because of mechanical damage. Both faults may necessitate having the motor rewound.

Page 59 of 124	Author/Copyright :- AGENA CONSTRUCTION AND INDUSTRIAL COLLEGE	Rewinding Single/Three Phase Induction Machine	Version -1 August, 2022
----------------	---	---	----------------------------



AGENA CONSTRUCTION AND INDUSTRIAL COLLEGE

Insulation Resistance Test.

This test is used to provide a quantifiable resistance value for all of a product's insulation. The test voltage is applied in the same fashion as a standard hipot test, but is specified to be Direct Current (DC). The voltage and measured current value are used to calculate the resistance of the insulation

It is a test carried out to determine the quality of the insulation between:

- The windings and the motor frame
- Between the individual windings

Insulation Resistance Tests Between Windings

Insulation Resistance Test between windings U and V. See Figure 26.

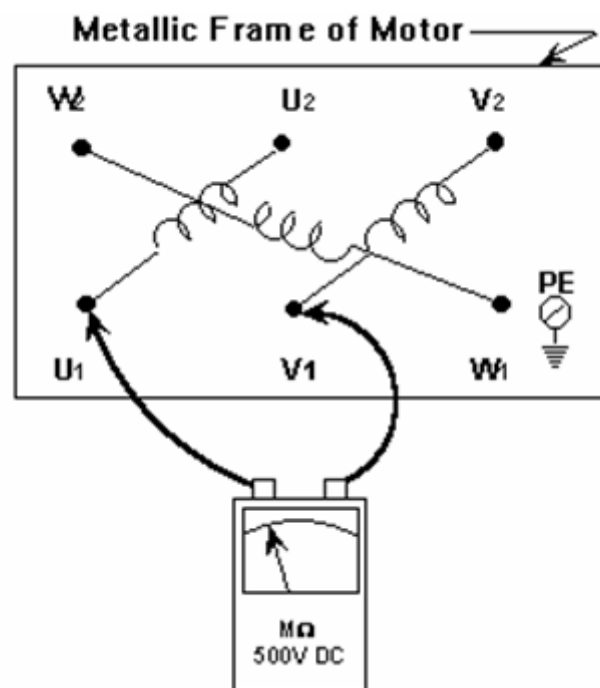

Figure 1.30 insulation resistance on motor

Page 60 of 124	Author/Copyright :- AGENA CONSTRUCTION AND INDUSTRIAL COLLEGE	Rewinding Single/Three Phase Induction Machine	Version -1 August, 2022
----------------	---	---	----------------------------



AGENA CONSTRUCTION AND INDUSTRIAL COLLEGE

If the motor becomes damp it may need drying out to obtain the minimum acceptable insulation resistance value. (2 M Ω)

High potential test

Hipot is an abbreviation for high potential. Traditionally, hipot is a term given to a class of electrical safety testing instruments used to verify electrical insulation in finished appliances, cables or other wired assemblies, printed circuit boards, electric motors, and transformers.

Under normal conditions, any electrical device will produce a minimal amount of leakage current due to the voltages and internal capacitance present within the product. Yet due to design flaws or other factors, the insulation in a product can break down, resulting in excessive leakage current flow. This failure condition can cause shock or death to anyone that comes into contact with the faulty product.

A hipot test (also called Dielectric Withstanding Voltage (DWV) test) verifies that the insulation of a product or component is sufficient to protect the operator from electrical shock. In a typical hipot test, high voltage is applied between a product's current-carrying conductors and its metallic shielding. The resulting current that flows through the insulation, known as leakage current, is monitored by the hipot tester. The theory behind the test is that if a deliberate over-application of test voltage does not cause the insulation to break down, the product will be safe to use under normal operating conditions—hence the name, Dielectric Withstanding Voltage test.

In addition to over-stressing the insulation, the test can also be performed to detect material and workmanship defects, most importantly small gap spacing between current-carrying conductors and earth ground. When a product is operated under normal conditions, environmental factors such as humidity, dirt, vibration, shock and contaminants can close these small gaps and allow current to flow. This condition can create a shock hazard if the defects are not corrected at the factory. No other test can uncover this type of defect as well as the Dielectric Withstand test.

Page 61 of 124	Author/Copyright :- AGENA CONSTRUCTION AND INDUSTRIAL COLLEGE	Rewinding Single/Three Phase Induction Machine	Version -1 August, 2022
----------------	---	---	----------------------------



AGENA CONSTRUCTION AND INDUSTRIAL COLLEGE

Dielectric strength test

Dielectric Breakdown Test. The test voltage is increased until the dielectric fails, or breaks down, allowing too much current to flow. The dielectric is often destroyed by this test so this test is used on a random sample basis. This test allows designers to estimate the breakdown voltage of a product's design and to see where the breakdown occurred.

Dielectric Withstanding Voltage Test. A standard test voltage is applied (below the established Breakdown Voltage) and the resulting leakage current is monitored. The leakage current must be below a preset limit or the test is considered to have failed. This test is non-destructive and is usually required by safety agencies to be performed as a 100% production line test on all products before they leave the factory.

Blocked rotor test is conducted on an induction motor. It is also known as short circuit test or locked rotor test or stalled torque test. From this test short circuit current at normal voltage, power factor on short circuit, total leakage reactance, starting torque of the motor can be found. The test is conducted at low voltage because if the applied voltage was normal voltage then the current flowing through the stator windings were high enough to overheat the winding and damage them. The *blocked rotor torque test* is not performed on a wound rotor motors because the starting torque can be varied as desired. However, *blocked rotor current test* is conducted on squirrel cage rotor motors.

Method

In the blocked rotor test, the rotor is locked. A low voltage is applied on the stator terminals so that full load current flows in the stator winding. The current, voltage and power input are measured at this point. When the rotor is stationary the slip. The test is conducted at the rated frequency as recommended by IEEE. This is because the rotor's effective resistance at low frequency may differ at high frequency. The test can be repeated for different values of voltage to ensure the values obtained are consistent. As the current flowing through the stator may exceed the rated current, the test should be conducted quickly. By using the parameters found by this test, the motor circle diagram can be constructed.

Page 62 of 124	Author/Copyright :- AGENA CONSTRUCTION AND INDUSTRIAL COLLEGE	Rewinding Single/Three Phase Induction Machine	Version -1 August, 2022
----------------	---	---	----------------------------



AGENA CONSTRUCTION AND INDUSTRIAL COLLEGE

Open circuit test or no-load test

Connect the circuit shown below to perform this test.

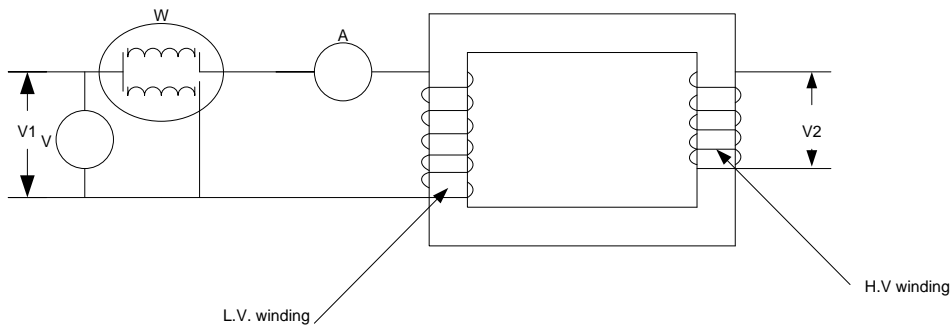

Figure 1.31 No load test

One winding of the transformer (usually high voltage winding) is left open and the other is connected to its supply of normal voltage and frequency. Ammeter and wattmeter are connected to measure no-load current and no load input power respectively.

Since current is very small copper loss is negligible, hence, the wattmeter will register the core loss. Since the core loss i.e. hysteresis loss (which is purely magnetic) and eddy current loss (which is electromagnetic in character) depend upon maximum value of the flux or flux density, it is constant and independent of the load.

Short circuit test or impedance test

This test is conducted to determine the full load copper loss.

The connection for this test is made as shown in figure below.

Page 63 of 124	Author/Copyright :- AGENA CONSTRUCTION AND INDUSTRIAL COLLEGE	Rewinding Single/Three Phase Induction Machine	Version -1 August, 2022
----------------	---	---	----------------------------



AGENA CONSTRUCTION AND INDUSTRIAL COLLEGE

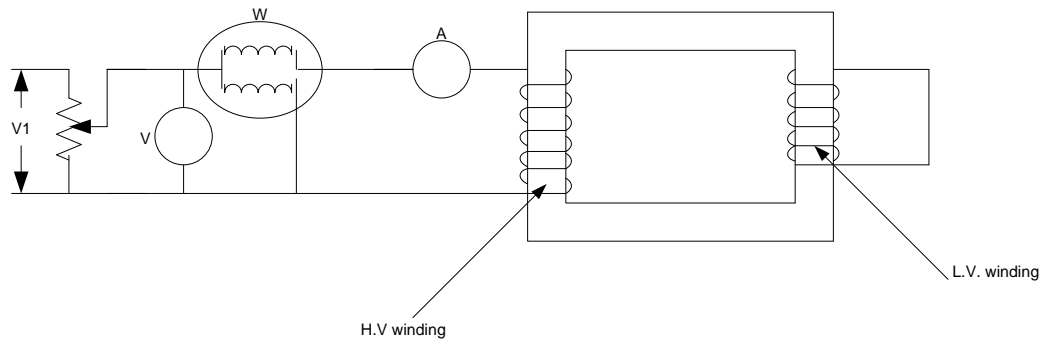

Figure 1.32 series coil group

The terminals of the secondary winding (usually low voltage winding) are short circuit by a thick conductor or through ammeter which may serve the additional purpose of indicating rated load current. A low voltage, usually 5-10% of normal primary voltage, at correct frequency is applied to the primary and is continuously increased till full load currents flow in primary as well as in secondary winding. Since applied voltage is very low so flux linking with core is very small and therefore, iron losses are small that can be neglected, the reading of wattmeter gives total copper loss at full load.

Open Circuit Test:

The open circuit test gives R_c and X_c . This test is performed by applying rated voltage to the low voltage side and leaving the high voltage side open. Either side may be used but the voltage is applied to the low voltage side for safety reasons.

With the output side left open in the previous figure and assuming that the shunt impedances (R_c and X_c) are much larger than the series impedances (R_1 and X_1) the equivalent circuit model reduces to the following diagram.

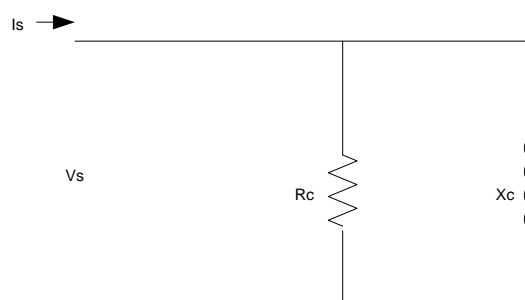

Page 64 of 124	Author/Copyright :- AGENA CONSTRUCTION AND INDUSTRIAL COLLEGE	Rewinding Single/Three Phase Induction Machine	Version -1
			August, 2022



AGENA CONSTRUCTION AND INDUSTRIAL COLLEGE

Figure 1.33 equivalent circuit

The values of R_c and X_c can be calculated using the following formulas from the voltage, current and power measured in this test.

$$S_{oc} = V_{oc} * I_{oc}$$

$$Q_{oc} = \sqrt{(S_{oc})^2 - (P_{oc})^2}$$

$$R_c = \frac{V_{oc}^2}{P_{oc}}$$

$$X_c = \frac{V_{oc}^2}{Q_{oc}}$$

Short Circuit Test:

The short circuit test gives R_1 , X_1 , R_2 and X_2 . This test is performed by applying rated current to the high voltage side and shorting the low voltage side. The high voltage side corresponds to the low current side, applying the test current to the low current side is done for safety reasons.

With the output side shorted in the first figure and assuming that the shunt impedances

(R_c and X_c) are much larger than the series impedances (R_1 , X_1 , R_2 and X_2) the equivalent circuit model reduces to the following diagram.

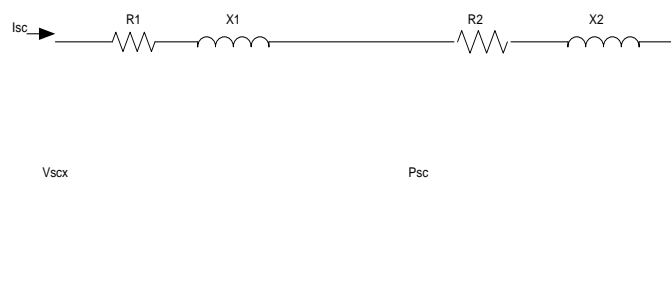

Figure 1.34 series coil group

Use the following formulas to find the equivalent impedances.

$$S_{sc} = V_{sc} * I_{sc}$$

Page 65 of 124	Author/Copyright :- AGENA CONSTRUCTION AND INDUSTRIAL COLLEGE	Rewinding Single/Three Phase Induction Machine	Version -1 August, 2022
----------------	---	---	----------------------------



AGENA CONSTRUCTION AND INDUSTRIAL COLLEGE

$$Q_{sc} = \sqrt{(S_{sc})^2 - (P_{sc})^2}$$

$$R_{eq} = \frac{P_{sc}}{(I_{sc})^2}$$

$$X_{eq} = \frac{Q_{sc}}{(I_{sc})^2}$$

Since we are using 1:1 transformers we can assume that $X1 = X2$ and $R1 = R2$, this gives the following formulas for the impedance values.

$$R1 = R2 = \frac{R_{eq}}{2} \quad \text{and} \quad X1 = X2 = \frac{X_{eq}}{2}$$

The performance of a transformer largely depends upon perfection of specific turns or voltage ratio of transformer. So **transformer ration test** is an essential type test of transformer. The voltage should be applied only in the high voltage winding in order to avoid unsafe voltage.

Actually the no load voltage ratio of transformer is equal to the turn ratio. So **ratio test of transformer**

Procedure of transformer ration test

- 1) First, the tap changer of transformer is kept in the lowest position and LV terminals are kept open.
- 2) Then apply 3-phase 415 V supply on HV terminals. Measure the voltages applied on each phase (Phase-Phase) on HV and induced voltages at LV terminals simultaneously.
- 3) After measuring the voltages at HV and LV terminals, the tap changer of transformer should be raised by one position and repeat test.
- 4) Repeat the same for each of the tap position separately.

The above **transformer ratio test** can also be performed by portable Transformer Turns Ratio (TTR) Meter. They have an in built power supply, with the voltages commonly used being very low, such as 8-10 V and 50 Hz. The HV and LV windings of one phase of a transformer

Page 66 of 124	Author/Copyright :- AGENA CONSTRUCTION AND INDUSTRIAL COLLEGE	Rewinding Single/Three Phase Induction Machine	Version -1 August, 2022
----------------	---	---	----------------------------



AGENA CONSTRUCTION AND INDUSTRIAL COLLEGE

are connected to the instrument, and the internal bridge elements are varied to produce a null indication on the detector.

Let's have a discussion on Transformer Turns Ratio (TTR) Meter method of **turn ratio test of transformer**

A phase voltage is applied to the one of the windings by means of a bridge circuit and the ratio of induced voltage is measured at the bridge. The accuracy of the measuring instrument is $< 0.1\%$

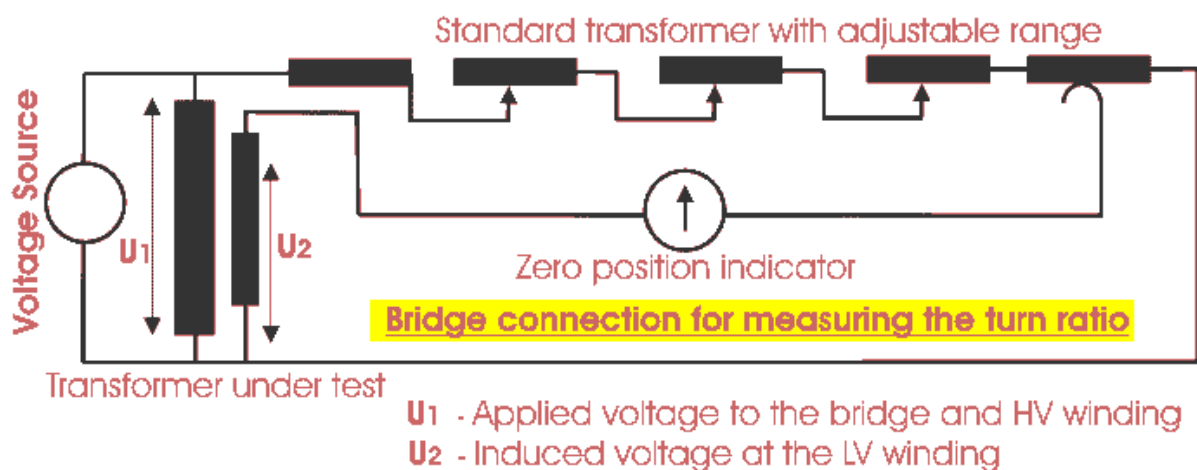

Figure 1.35 Turn ratio test

$$\text{Theoretical turn ratio} = \frac{\text{HV winding voltage}}{\text{LV winding voltage}}$$

This theoretical turn ratio is adjusted on the transformer turn ratio tested or TTR by the adjustable transformer as shown in the figure above and it should be changed until a balance occurs in the percentage error indicator. The reading on this indicator implies the deviation of measured turn ratio from expected turn ratio in percentage.

Page 67 of 124	Author/Copyright :- AGENA CONSTRUCTION AND INDUSTRIAL COLLEGE	Rewinding Single/Three Phase Induction Machine	Version -1
			August, 2022



AGENA CONSTRUCTION AND INDUSTRIAL COLLEGE

$$\text{Deviation in percentage} = \frac{\text{Measured turn ratio} - \text{expected turn ratio}}{\text{Expected turn ratio}} \times 100 \%$$

Out-of-tolerance, **ratio test of transformer** can be due to shorted turns, especially if there is an associated high excitation current. Open turns in HV winding will indicate very low exciting current and no output voltage since open turns in HV winding causes no excitation current in the winding means no flux hence no induced voltage. But open turn in LV winding causes, low fluctuating LV voltage but normal excitation current in HV winding. Hence open turns in LV winding will be indicated by normal levels of exciting current, but very low levels of unstable output voltage. The **turn ratio test of transformer** also detects high resistance connections in the lead circuitry or high contact resistance in tap changers by higher excitation current and a difficulty in balancing the bridge.

For both Insulation Resistance Tests the minimum acceptable value is 2M Ω ; however a much higher reading would normally be expected.

If the motor becomes damp it may need drying out to obtain the minimum acceptable insulation resistance value.

An Insulation Resistance Test should also be done between the windings and any starting equipment, e.g. capacitor(s), centrifugal switch and associated cables.

Page 68 of 124	Author/Copyright :- AGENA CONSTRUCTION AND INDUSTRIAL COLLEGE	Rewinding Single/Three Phase Induction Machine	Version -1 August, 2022
----------------	---	---	----------------------------



AGENA CONSTRUCTION AND INDUSTRIAL COLLEGE

Self-check-1

Test-I Multiple Choice

- Name plate data of Ac induction motor does not include
 - Actual speed
 - voltage rating
 - synchronous speed
 - current rating
- The speed of a squirrel-cage induction motor depends on
 - voltage applied.
 - frequency and number of poles.
 - field strength.
 - current strength
- Synchronous speed (N_s) is calculated using the formula
 - $P = \frac{120f}{N}$
 - $N_s = \frac{120f}{P}$
 - $N_s = \frac{120f}{N}$
 - $N = \frac{120f}{P}$
- The squirrel-cage induction motor is popular because of its characteristics of
 - high percent slip.
 - low percent slip.
 - simple, rugged construction.
 - good speed regulation
- A data/s which cannot be collected without disassembling motor is/are:
 - Frequency
 - pole
 - number of slots
 - number of phase
- Original winding data which cannot be collected by visual inspection is:
 - Slot
 - pole
 - coil pitch
 - coil side
- An induction motor which having 4 pole will develop a synchronous speed of _____ when supplied from 380V/50Hz supply.
 - 3000rpm
 - 1500rpm
 - 1000rpm
 - 750rpm
- This figure illustrates
 - Delta connected three phase motor
 - Star connected three phase motor

Page 69 of 124	Author/Copyright :- AGENA CONSTRUCTION AND INDUSTRIAL COLLEGE	Rewinding Single/Three Phase Induction Machine	Version -1 August, 2022
----------------	---	---	----------------------------



AGENA CONSTRUCTION AND INDUSTRIAL COLLEGE

- c.Center tapped three phase motor
- d.Dahlander type three phase motor

-
9. The most common types of single layer winding of induction motor
- a. Concentric winding
 - b. mush winding
 - c. chain winding
 - d. all
10. Number of slot per phase per pole is found by the formula
- a. $q = \frac{S}{P \times m}$
 - b. $k = \frac{3}{2} * P$
 - c. $k = \frac{S}{P \times m}$
 - d. $yz = \frac{S}{P}$
11. For machine having data of $S = 36$, $P = 4$, $m = 3$, $a = 1$, single layer chain three phase ac type. Calculate the winding pitch (Y_z) and the slot difference between the first phase and the next phase () respectively.
- a. 9&4
 - b. 9&3
 - c. 9&6
 - d. 6&6
12. From the data given under question 10 find number of coils (K) and number of slots per phase per pole (q) respectively.
- a. 4&2
 - b. 4&3
 - c. 6&2
 - d. 4&4
13. In order to connect coil groups of double layer winding in series the connection must be:
- a. Finish of one group to start of next group.
 - b. Finish of one group to finish of next group.
 - c. Randomly at each coil ends.
 - d. At interval of winding pitches.
14. A correct sequence to connect three phase Ac induction motor is:
- a. $U_1 - V_2$, $V_1 - U_2$, and $W_1 - V_2$
 - b. $U_1 - W_2$, $V_1 - U_2$, and $W_1 - V_2$
 - c. $U_1 - W_2$, $V_1 - U_1$, and $W_1 - W_2$
 - d. $U_1 - W_2$, $V_1 - U_2$, and $W_1 - V_2$
15. Which of the following is **not** true about ac induction motor?
- a. It has two main parts (rotor and stator).
 - b. Electromagnet is formed in the stator when connected to ac supply.
 - c. It needs dc supply for rotor parts.
 - d. Its actual speed (N) is always less than synchronous speed (N_s).

Page 70 of 124	Author/Copyright :- AGENA CONSTRUCTION AND INDUSTRIAL COLLEGE	Rewinding Single/Three Phase Induction Machine	Version -1 August, 2022
----------------	---	---	----------------------------



AGENA CONSTRUCTION AND INDUSTRIAL COLLEGE

Test-II True/False

_____ 1. Clamp ammeter is an instrument used for measuring the insulation resistance of electrical devices.

_____ 2. Coil pitch tells the number of slots in which windings formed from group of conductors is accommodated.

_____ 3. Number of slot is not important data to draw complete winding diagram of three phase induction machine.

_____ 4. In concentric type winding coil pitch is the same for all coils in one coil groups.

_____ 5. Number of poles in ac machine can be odd number to increases speed of ac induction machine.

Test-III Short answer.

1. List at least five data that can be collected without disassembling ac motor.

2. Give examples of consumable materials that is used for completing rewinding job.

3. What test are conducted under task of electriccal tests?.

Page 71 of 124	Author/Copyright :- AGENA CONSTRUCTION AND INDUSTRIAL COLLEGE	Rewinding Single/Three Phase Induction Machine	Version -1
			August, 2022



AGENA CONSTRUCTION AND INDUSTRIAL COLLEGE

Test-IV Short Answer

1. Develop complete winding diagram based on the following data.

Given data. $S = 36$, $P = 4$, $m = 3$ and $a = 1$.

Operation Sheet 1.1 Data collection for rewinding

- **Operation title:** Taking name plate and internal data of three phase Ac induction Motor.
- **Purpose:** To collect appropriate data from the machine to be wound.
- **Instruction:** referring figure shown in each step below and given equipment collect the data of machine for rewinding. You have given 30 minute for the task and you are expected to write the answer on the given machine.

Tools, Equipment, and Materials

ITEM:	QTY
1. Electrician hand tool	1 set
2. Nut-spinner	1 set
3. Pen and paper	as required

Page 72 of 124	Author/Copyright :- AGENA CONSTRUCTION AND INDUSTRIAL COLLEGE	Rewinding Single/Three Phase Induction Machine	Version -1 August, 2022
----------------	---	---	----------------------------



AGENA CONSTRUCTION AND INDUSTRIAL COLLEGE

- **Steps in doing the task**

1. Before disassembling put identification mark on motor to be disassembled, use marker which cannot easily fadeout.

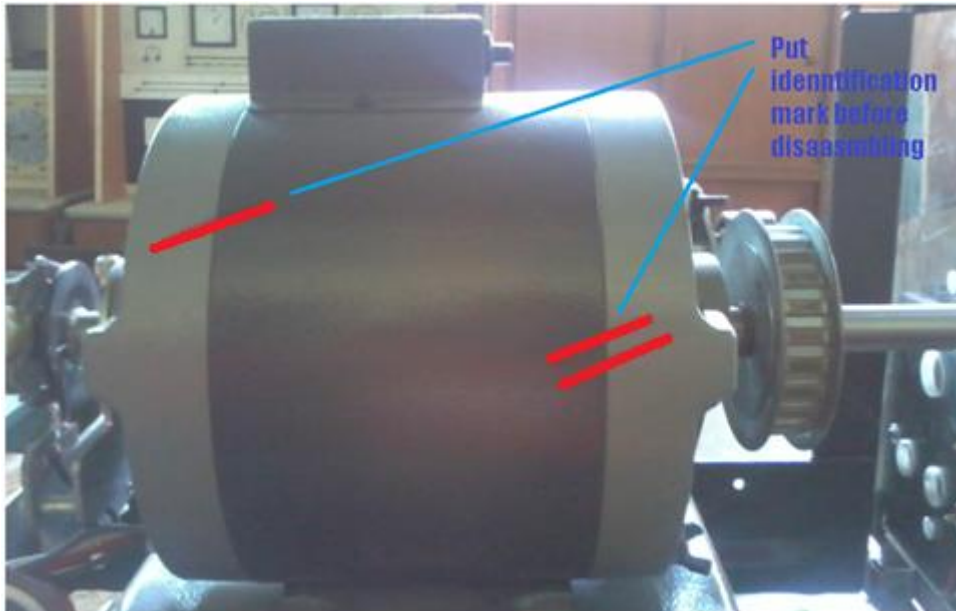

Figure 1.36 sign before disassembling

2. Place the parts according to disassembling procedure; be sure that last disassembled will be assembled first.



Figure 1.37 part storing

3. Read the data as shown below on fig- and record each on paper.

Page 73 of 124	Author/Copyright :- AGENA CONSTRUCTION AND INDUSTRIAL COLLEGE	Rewinding Single/Three Phase Induction Machine	Version -1
			August, 2022



AGENA CONSTRUCTION AND INDUSTRIAL COLLEGE

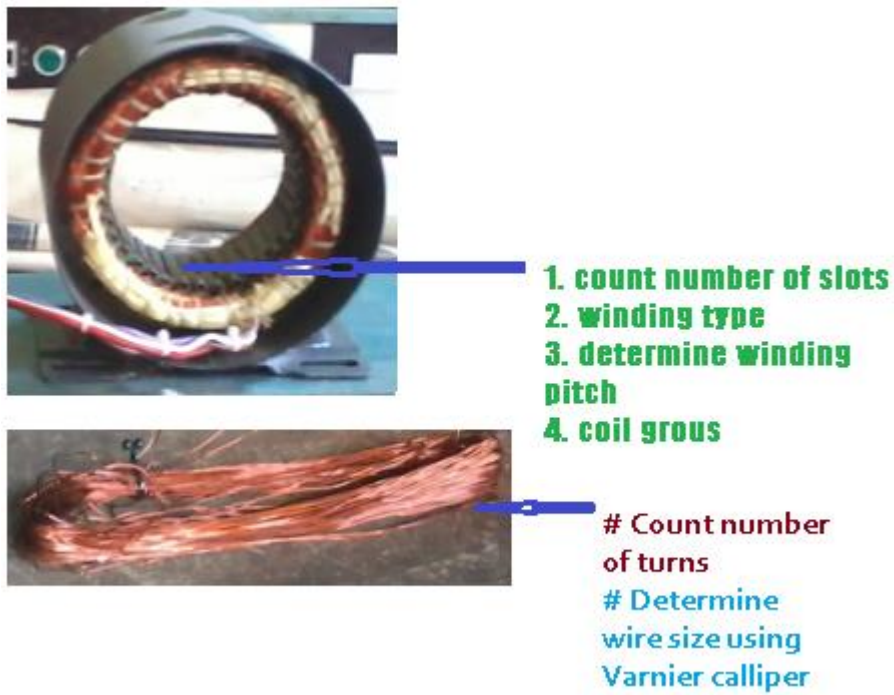

Figure 1.38 taking internal data

5. Use the following table to record all datas together

Table 1.6 Data recording form

Voltage rating:	Number of slots:
Current rating:	Winding type:
Frequency:	Winding pitch:
Power raing:	Coil groups:
Speed:	Number of urns:
Number of phase:	Wire size:
Power factor:	



AGENA CONSTRUCTION AND INDUSTRIAL COLLEGE

6. Record additional data based on the type of motor construction.

- **Quality Criteria:** the given machine specification affect greatly the performance characteristic of operation.
- **Precautions:** use PPE and always think that electric is your dangerous servant.

Operation Sheet 1.2 Data collection for rewinding

- **Operation title:** Drawing complete winding diagram of three phase Ac motor.
- **Purpose:** to draw complete winding diagram based on collected data on operation sheet 1.1.
- **Instruction:** referring figure shown in each step below and given equipment draw complete winding diagram. You have given 2hr for the task and you are expected to write the answer on the given machine.

Tools, Equipment, and Materials

ITEM:

1. Pencil
2. A4, and A3 paper
3. Drawing instrument

QTY

As required
As required
1 set

- **Steps in doing the task**

1:Based on collected data from operation sheet 1.1, complete by calculating the necessary data (refer information sheet one)

Data collected (replace all based on motor type)

$S = 24, P = 4, m = 3, a = 1$ (series winding) and chain winding.

$$Yz = S/P = 24/4 = 6$$

$$k = (3/2)*P = 3/2*4 = 6$$

Page 75 of 124	Author/Copyright :- AGENA CONSTRUCTION AND INDUSTRIAL COLLEGE	Rewinding Single/Three Phase Induction Machine	Version -1 August, 2022
----------------	---	---	----------------------------



AGENA CONSTRUCTION AND INDUSTRIAL COLLEGE

$$k/m = 6/3 = 2 \text{ coil groups/phase}$$

$$q = \frac{S}{P \cdot m} = \frac{24}{4 \cdot 3} = 2$$

$$\Upsilon = 180^\circ \cdot P = 180^\circ \cdot 4 = 720^\circ$$

$$\alpha_s = \Upsilon/S = 720^\circ/24 = 30^\circ$$

$$\lambda = 120^\circ/\alpha_s = 120^\circ/30^\circ = 4 \text{ slots}$$

Phase sequence

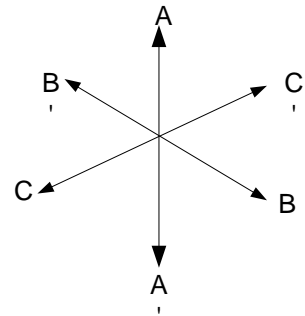
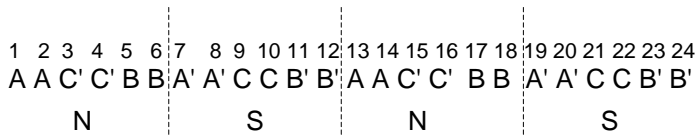

Connection Diagram

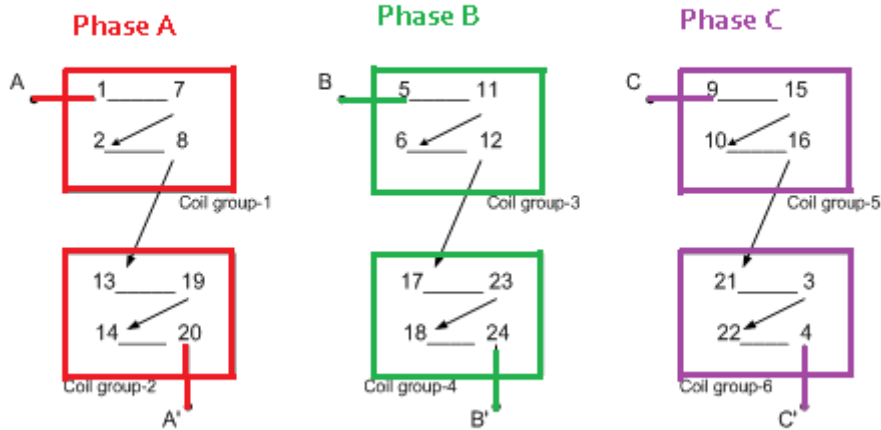

Figure 1.39 connection diagram

2: Draw the number of slot as shown in fig 1.40

Page 76 of 124	Author/Copyright :- AGENA CONSTRUCTION AND INDUSTRIAL COLLEGE	Rewinding Single/Three Phase Induction Machine	Version -1 August, 2022
----------------	---	---	----------------------------



AGENA CONSTRUCTION AND INDUSTRIAL COLLEGE

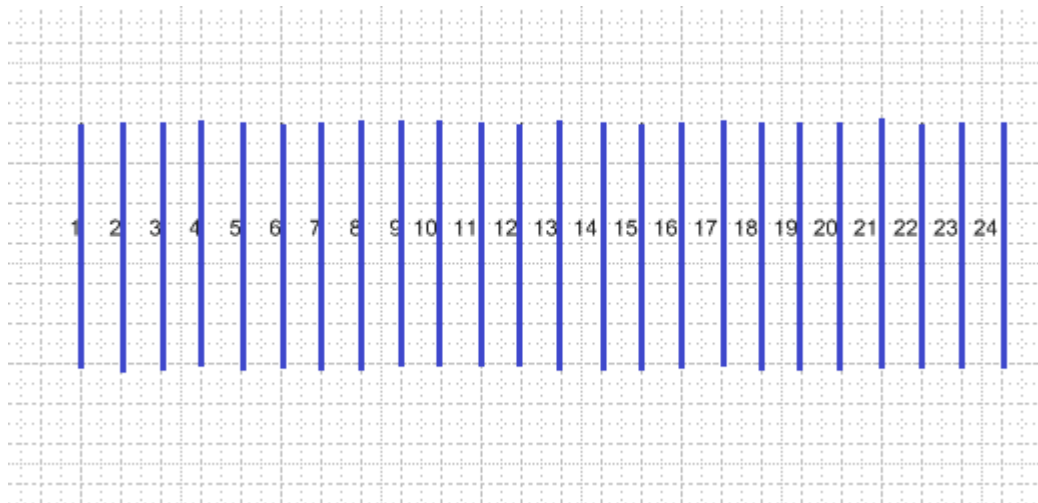

Figure 1.40 slot representation

3: put coils for phase A (for detail information refer information sheet 1)

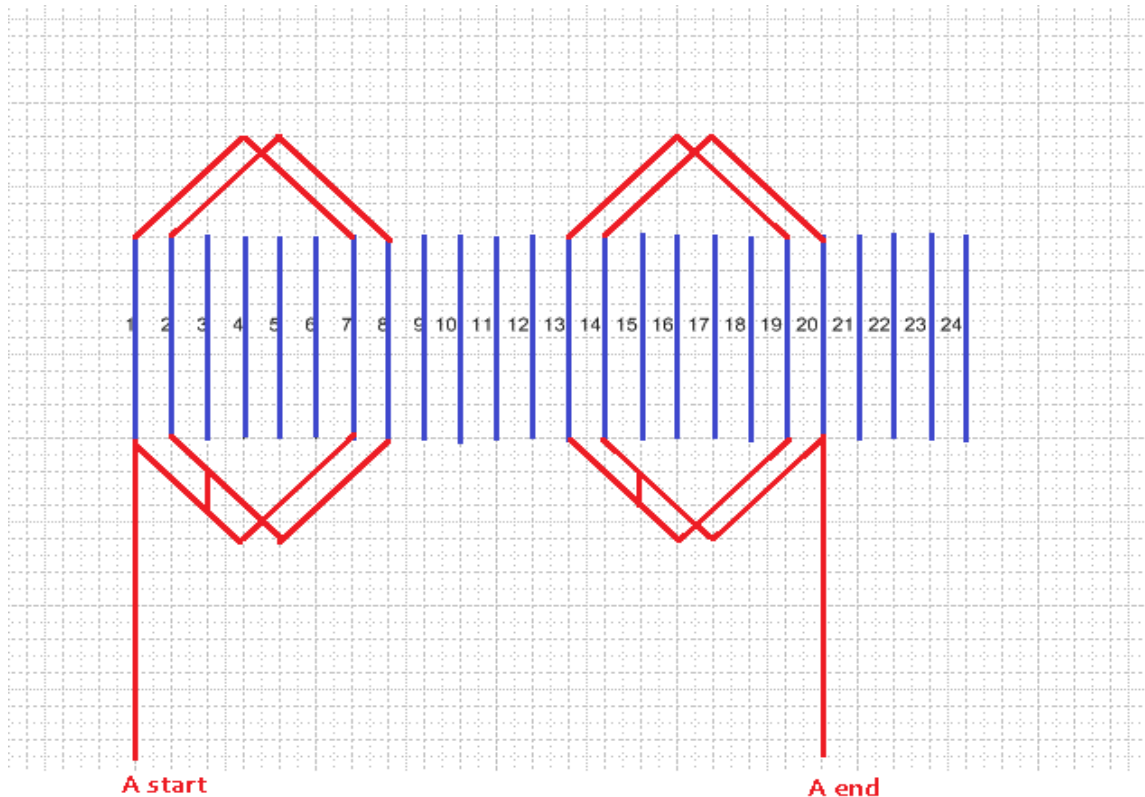

Figure 1.41 coil laying

4: Add coils for phase B

Page 77 of 124	Author/Copyright :- AGENA CONSTRUCTION AND INDUSTRIAL COLLEGE	Rewinding Single/Three Phase Induction Machine	Version -1
			August, 2022



AGENA CONSTRUCTION AND INDUSTRIAL COLLEGE

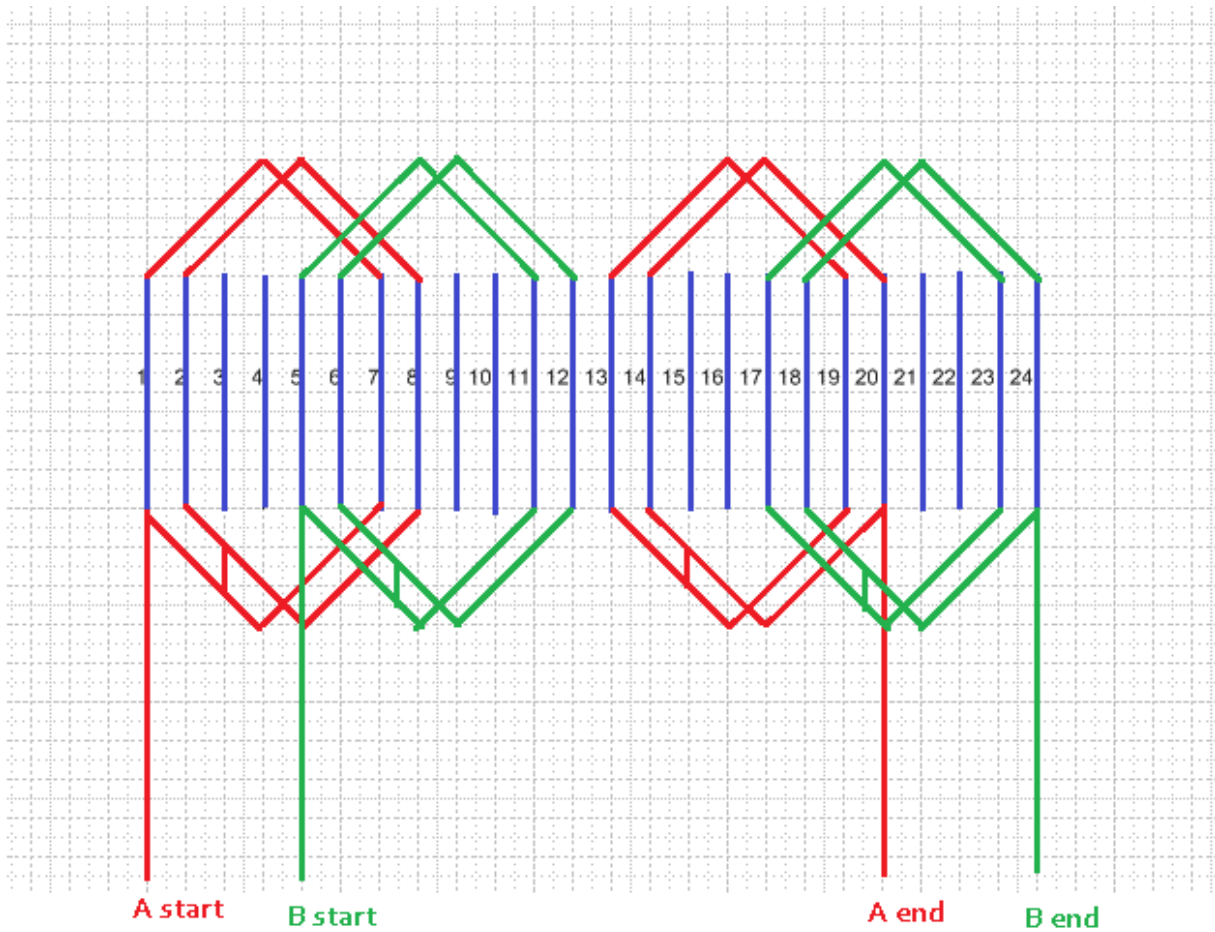



AGENA CONSTRUCTION AND INDUSTRIAL COLLEGE

5: add coil for phase C

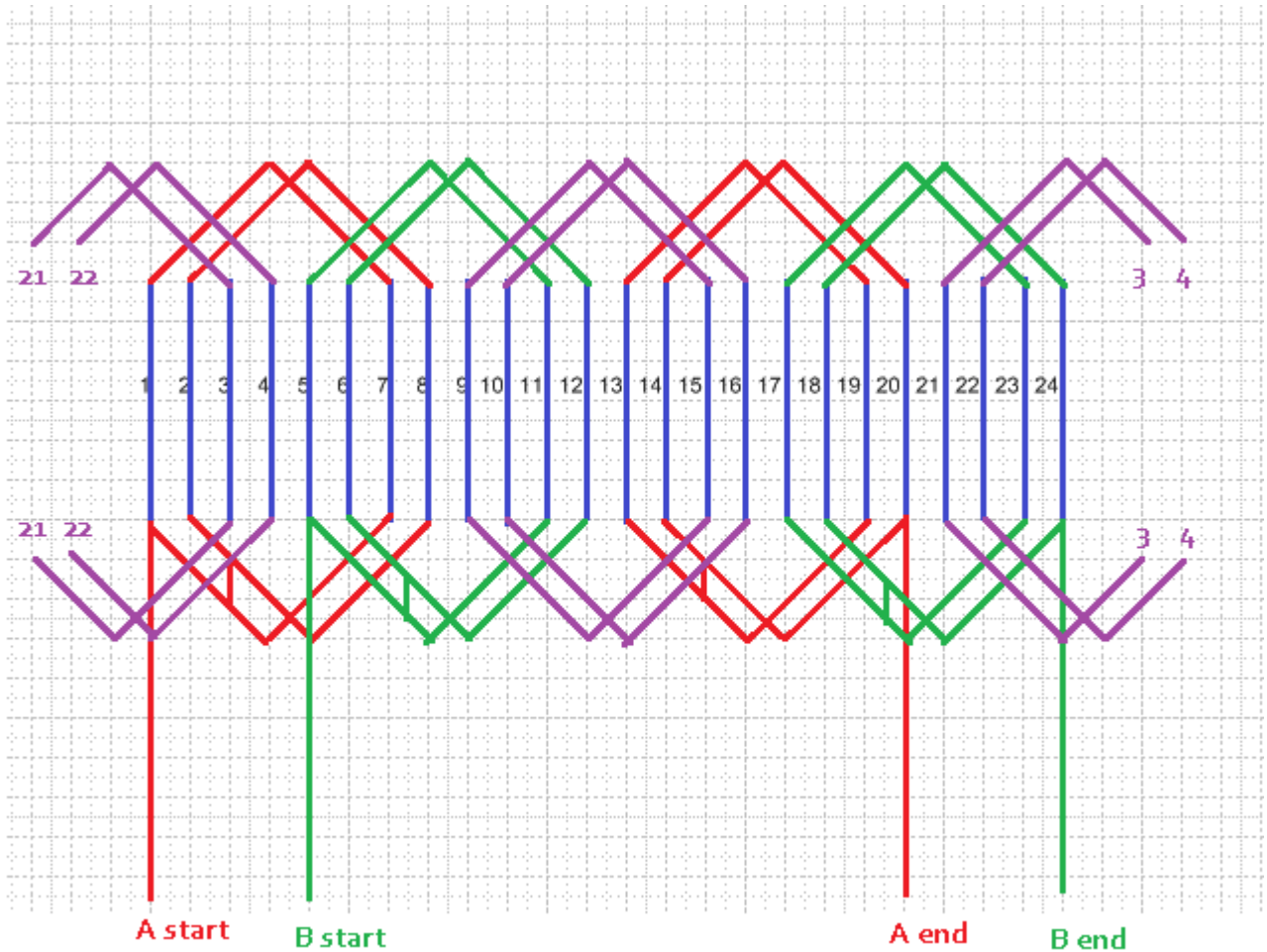

Figure 1.42 three phases laid

Page 79 of 124	Author/Copyright :- AGENA CONSTRUCTION AND INDUSTRIAL COLLEGE	Rewinding Single/Three Phase Induction Machine	Version -1
			August, 2022



AGENA CONSTRUCTION AND INDUSTRIAL COLLEGE

6: show number of poles on the winding to complete the drawing

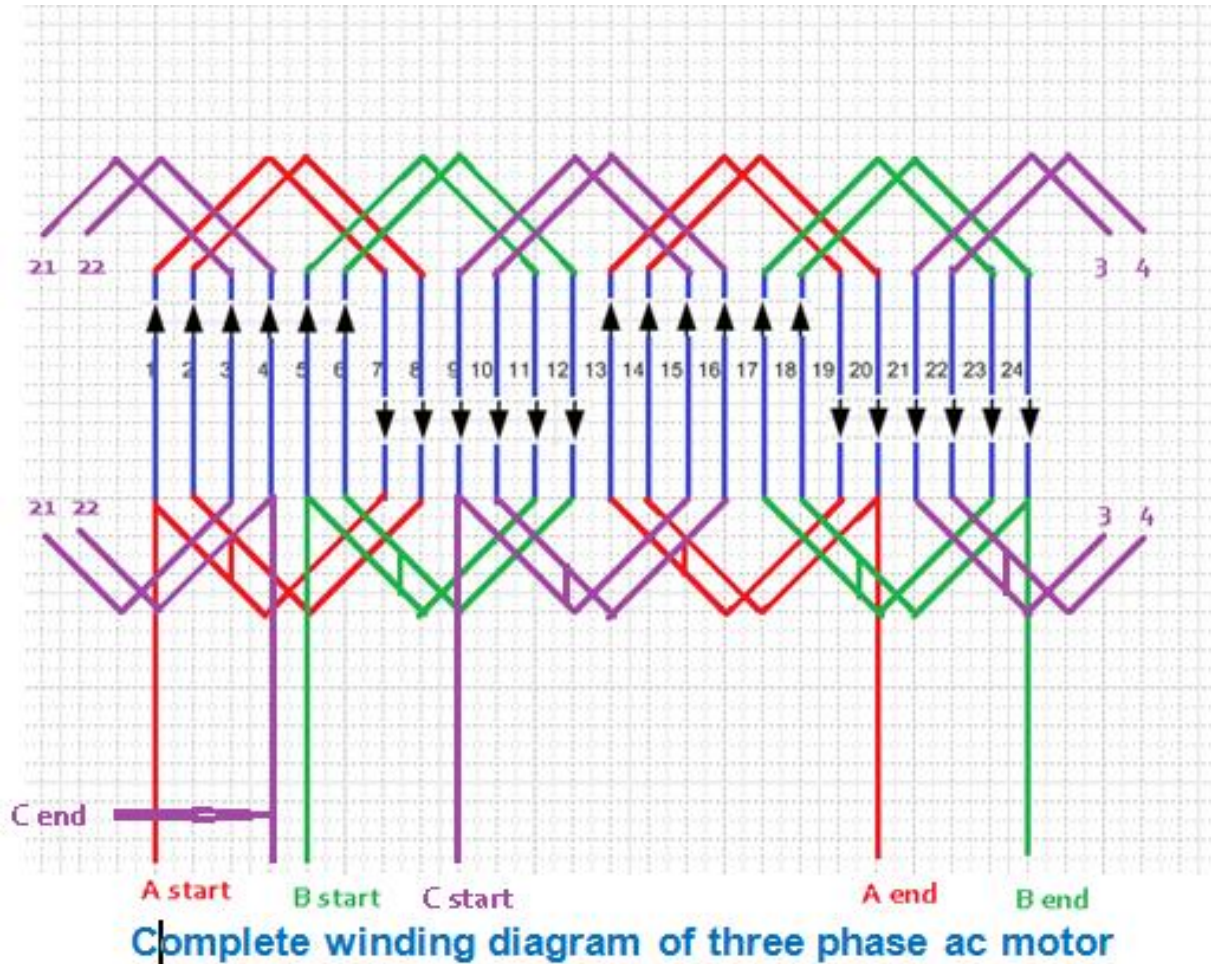

Figure 1.43 complete diagram

- **Quality Criteria:** the given machine specification affect greatly the performance characteristic of operation.
- **Precautions:** use PPE and always think that electric is your dangerous servant.

LAP Test 1. Draw complete winding diagram of three phase Ac motor

Task 1: Take name plate and internal data of three phase Ac induction Motor.

Task 2: Draw complete winding diagram of three phase Ac motor.

Page 80 of 124	Author/Copyright :- AGENA CONSTRUCTION AND INDUSTRIAL COLLEGE	Rewinding Single/Three Phase Induction Machine	Version -1 August, 2022
----------------	---	---	----------------------------



AGENA CONSTRUCTION AND INDUSTRIAL COLLEGE

Unit Two: Windings of Electrical coils

This unit to provide you the necessary information regarding the following content coverage and topics:

- Preparation of winding electrical coils
- Winding of small and medium-sized solenoid coils, contactor coil
- assembling processes
- risk minimization in case of unplanned events

This guide will also assist you to attain the learning outcomes stated in the cover page. Specifically, upon completion of this learning guide, you will be able to:

- Prepare winding of electrical coils
- Wind small and medium-sized solenoid coils, contactor coils
- Apply assembling processes
- Minimize risk in case of unplanned events

Page 81 of 124	Author/Copyright :- AGENA CONSTRUCTION AND INDUSTRIAL COLLEGE	Rewinding Single/Three Phase Induction Machine	Version -1
			August, 2022



AGENA CONSTRUCTION AND INDUSTRIAL COLLEGE

2.1 Preparation of winding electrical coils

A solenoid is a type of electromagnetic formed by helical coil of wire whose length is substantially greater than its diameter, which generates a controlled magnetic field. The coil can produce a uniform magnetic field in a volume of space when an electric current is passed through it.

Solenoid Construction

A solenoid is a long wire, wound with a helical pattern, usually surrounded by a steel frame, having a steel core inside the winding. When carrying a current "i", the solenoid becomes an electro-mechanical device, in which electrical energy is converted into mechanical work.

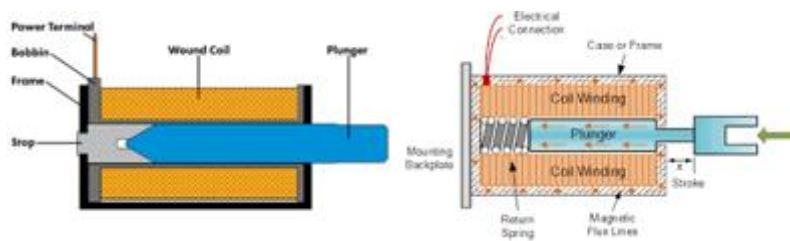

Figure 2.1 structure of solenoid

In engineering, the term solenoid may also refer to a variety of transducer devices that convert energy into linear motion. The term is also often used to refer to a solenoid valve, which is an integrated device containing an electromechanical solenoid which actuates either a pneumatic or hydraulic valve, or a solenoid switch, which is a specific type of relay that internally uses an electromechanical solenoid to operate an electrical switch; for example, an automobile starter solenoid, or a linear solenoid, which is an electromechanical solenoid.

Quantitative description



AGENA CONSTRUCTION AND INDUSTRIAL COLLEGE

Now we can consider the imaginary loop b . Take the line integral of B around the loop, with the length of the loop l . The horizontal components vanish, and the field outside is practically zero, so Ampère's Law gives us:

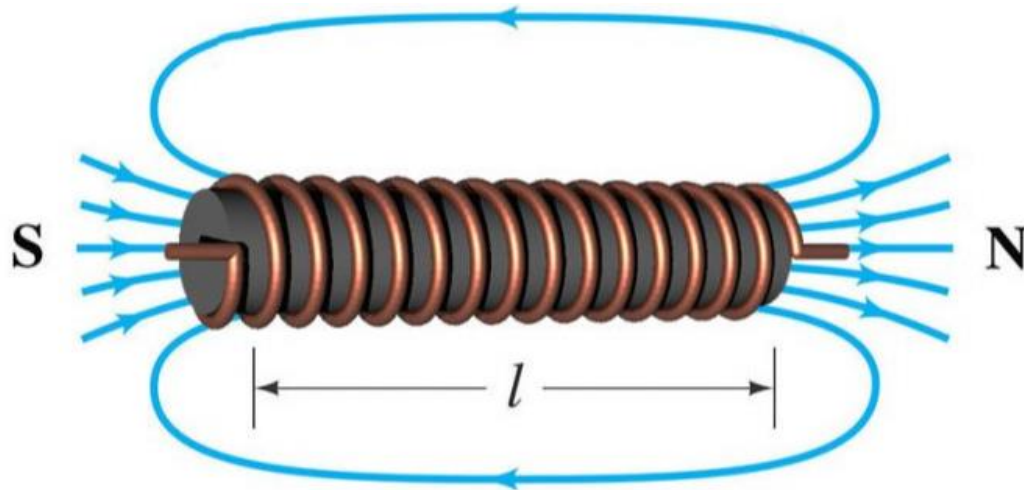

Figure 2.2 solenoid coil

$$Bl = \mu_0 Ni$$

Where μ_0 is the magnetic constant, N the number of turns, i the current. This equation is for a solenoid with no core. The inclusion of a ferromagnetic core, such as iron, increases the magnitude of the magnetic field in the solenoid. This is expressed by the formula

μ_0 is the magnetic constant whose value is $4\pi \times 10^{-7} \text{T.m/A}$ or $12.57 \times 10^{-7} \text{T.m/A}$,

$$B = \mu_0 \mu_r \frac{Ni}{l}$$

Where μ_r is the relative permeability of the material that the core is made of. $\mu_0 \mu_r$ is the permeability (μ) of the core material such that:

$$B = \mu \frac{Ni}{l}$$

Page 83 of 124	Author/Copyright :- AGENA CONSTRUCTION AND INDUSTRIAL COLLEGE	Rewinding single/three phase induction machine	Version -1 August, 2022
----------------	--	---	----------------------------



AGENA CONSTRUCTION AND INDUSTRIAL COLLEGE

Say wire that carries a constant current of 0.9A is formed into a solenoid of length 310mm. the strength of the magnetic field at the center of the solenoid is measured to be $7.7 \times 10^{-4} \text{T}$. Calculate the number of turns used to form the solenoid, giving your answer to the nearest whole number of turns. Use a value of $4\pi \times 10^{-7} \text{ Hm}$ for μ_0

$$N = (0.310\text{m} * 7.7 \times 10^{-4} \text{T}) / (4\pi \times 10^{-7} \text{ Hm} * 0.9\text{A}) \quad (1000\text{mm} = 1\text{m}, \text{ hence } 330\text{mm} = 0.310\text{m})$$

$$N = 211 \text{ turns}$$

Number of Turns (N)

The construction of contactor coil is the same to transformer coil except it has only one coil placed in the core.

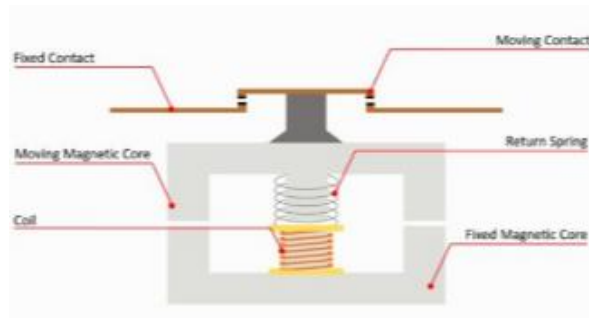

Figure 2.3 structure of contactor

The number of turns in a coil depends upon the cross-section of a core on which it is mounted. If the core's cross-section is known, the number of turns per volt depending upon coil duty can be determined from figure the figure below.

Page 84 of 124	Author/Copyright :- AGENA CONSTRUCTION AND INDUSTRIAL COLLEGE	Rewinding single/three phase induction machine	Version -1
			August, 2022



AGENA CONSTRUCTION AND INDUSTRIAL COLLEGE

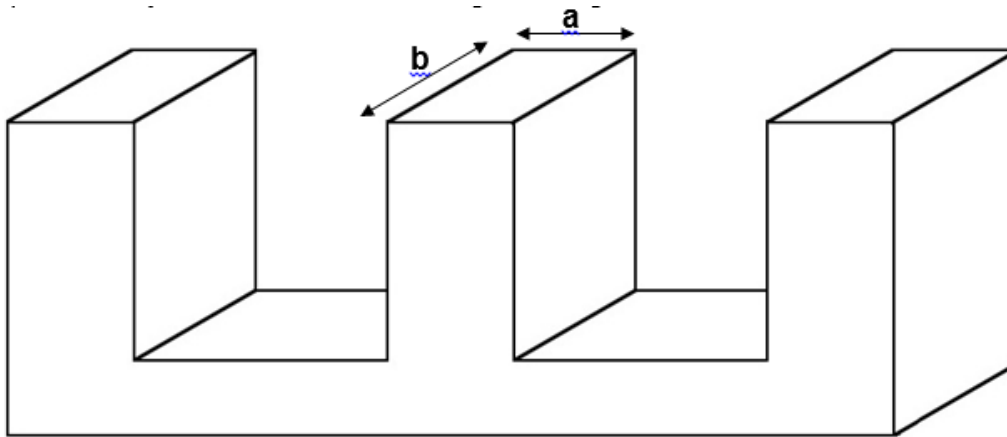

Figure 2.4 core of contactor

Core cross-section is:

$$c = a \times b \text{ (unit in cm}^2\text{)}$$

Where; a is the core length in cm (i.e. 2 cm)

b is the core width in cm (i.e. 2 cm)

For example, the core cross-section of a 220 volts primary winding and 12-0-12 volts secondary winding to be designed for continuous duty is 4.0 cm² then the number of turns per volt depending coil duty can be determined from graph becomes 6 turns per volt. It may vary refer more on the graph to understand.

Formula is : $N = \text{Operating Voltage} \times \text{Number of turns per volt}$

The total number of turns for a 220 Volts primary winding is:

$$N = 220 \times 6$$

$$N = 1,320 \text{ turns}$$

The total number of turns for a 12-0-12 Volts secondary winding is:

$$N = 24 \times 6$$

Page 85 of 124	Author/Copyright :- AGENA CONSTRUCTION AND INDUSTRIAL COLLEGE	Rewinding single/three phase induction machine	Version -1 August, 2022
----------------	--	---	----------------------------



AGENA CONSTRUCTION AND INDUSTRIAL COLLEGE

$N = 144$ turns

The same to that of transformers, the maximum flux density in any part of core and yokes, at normal voltage and frequency at all taps shall be such that the flux density under over fluxing conditions as mentioned in standards, shall , not exceed 1.9 Tesla for company and 1.48Tfor conventional grade of Amourpohs core and 1.56T.

Number of turns of a coil formula is given for both total number of turns and turns per volts formula is derived as:

$$T_e = 1/(4.44 * F * M * A)$$

$$T = T_e * V$$

Where,

T_e = Turns per Volts

V = Voltage

F = operating frequency

M = magnetic flux and

A = area of core. Total number of turns formula is defined as (turns per volts times voltage).

2.2. Winding of small and medium-sized solenoid coils, contactor coil

By referring to sub title 2.1 and based on the data rewind coils either manually or automatically and make it ready for assembling.

Page 86 of 124	Author/Copyright :- AGENA CONSTRUCTION AND INDUSTRIAL COLLEGE	Rewinding single/three phase induction machine	Version -1
			August, 2022



AGENA CONSTRUCTION AND INDUSTRIAL COLLEGE

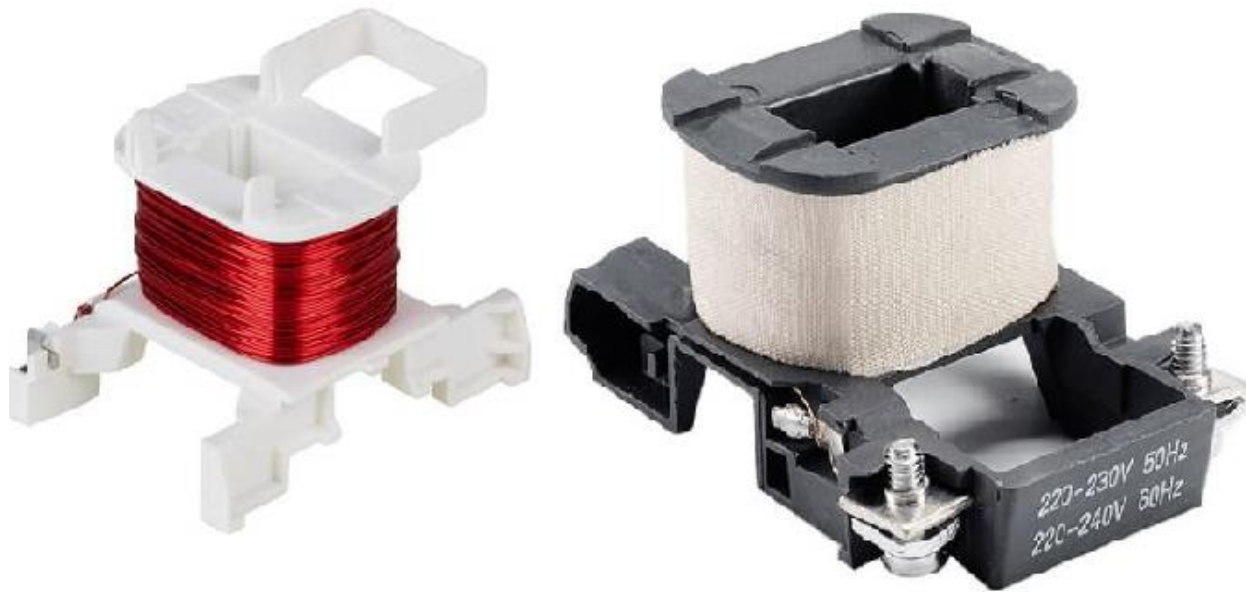

Figure 2.5 contactor winding

2.3. Assembling processes

Assembling has great factor on functionality of solenoid and contactor coil because there is mechanical motion in parts.

Select appropriate tools as per their design intent to minimize mechanical damage both to tools and the parts to be assembled.

Assemble each part on their right position as it was before disassembled. Think that mechanical mismatch both led to mechanical and electrical faults.

Varnish or paint the laminations, then you must be careful to insert them all with the paint-side uppermost. Another point is that it will not be possible to fit them all in.

Measure and compare the resistance value with that of expected after completion of rewinding.

In assembling of the winding coils always remember the following points.

Test and observe for:

- I. Vibration when operated at rated voltage.
- II. Overheating in the coil.

Page 87 of 124	Author/Copyright :- AGENA CONSTRUCTION AND INDUSTRIAL COLLEGE	Rewinding single/three phase induction machine	Version -1 August, 2022
----------------	--	---	----------------------------



AGENA CONSTRUCTION AND INDUSTRIAL COLLEGE

III. Humming sound in the equipment

If the coil is subjected to any unsound operation while testing, think from different angles such as, determination of number of turn, wire size selection, mechanical fitness, etc.

2.4. Risk minimization in case of unplanned events

Accidents, malfunctions and unplanned events refers to events or upset conditions that are not part of any activity or normal operation of the project. even with the best planning and the implementation of preventative measures, the potential exists for accidents, malfunctions or unplanned events to occur during any project phase, and if they occur, for adverse environmental effects to result if these events are not addressed or responded to in an environmentally appropriate manner. many accidents, malfunctions and unplanned events are, however, preventable and can be readily addressed or prevented by good planning, design, emergency response planning, and mitigation. by identifying and assessing the potential for these events to occur, can be identified and put in place prevention and response procedures to minimize or eliminate the potential for significant adverse environmental effects, should an accidental event occur.

Prevention and mitigation will be accomplished by the following general principles:

- use best management practices and technology for carrying out the project while controlling permitted/allowable releases to the environment and consequent environmental effects;
- incorporate safety and reliability by design, and application of principles and practices of process and mine safety management;
- develop and apply procedures and training aimed at safe operation of the facilities that prevent or avoid the potential upsets that might lead to accidents, malfunctions or unplanned events; and
- Implement effective emergency preparedness and response.

Page 88 of 124	Author/Copyright :- AGENA CONSTRUCTION AND INDUSTRIAL COLLEGE	Rewinding single/three phase induction machine	Version -1 August, 2022
----------------	--	---	----------------------------



AGENA CONSTRUCTION AND INDUSTRIAL COLLEGE

Self-Check 2

Test I. Multiple Choice

1. What is/are factors that determines the number turns in solenoid coil?
 - a. Current rating
 - b. Length of core
 - c. Voltage rating rate
 - d. a and c
2. for contactor coil the number of turn depends on:
 - a. current rating
 - b. area of core
 - c. voltage rating
 - d. b and c
3. One of the following tool has no application in winding task of solenoid coil.
 - a. Screw driver
 - b. Rubber hammer
 - c. Plier
 - d. Electrician knife
4. Basic instrument/s those required for contactor winding is/are.
 - a. Tachometer
 - b. Multimeter
 - c. Clamp on meter
 - d. Megger
5. Which of the following is true about winding personnel.
 - a. Selecting and using PPE
 - b. Selecting appropriate material
 - c. Obeying safety rule and regulations
 - d. all

Page 89 of 124	Author/Copyright :- AGENA CONSTRUCTION AND INDUSTRIAL COLLEGE	Rewinding single/three phase induction machine	Version -1 August, 2022
----------------	--	---	----------------------------



AGENA CONSTRUCTION AND INDUSTRIAL COLLEGE

Test II True/False

_____ 1. For short period of time it is possible to use 220V contactor instead of 380V rated on three phase supply system.

_____ 2. Wire diameter affect the current rating solenoid coil indirectly affecting the number of turn.

_____ 3. If over vibration happen it is not major fault of contactor after completion of rewinding task.

_____ 4. Poor assembling procedure may lead to severe material damage and human injury that may rang o death.

_____ 5. Applying correct testing procedures may give possible causes of fault which results malfunction of equipment/system.

Test III Short Answer.

1. Write operation principle of solenoid coil.

2. List out the symptom of fault contactor coil

Page 90 of 124	Author/Copyright :- AGENA CONSTRUCTION AND INDUSTRIAL COLLEGE	Rewinding single/three phase induction machine	Version -1
			August, 2022



AGENA CONSTRUCTION AND INDUSTRIAL COLLEGE

Operation Sheet 2: Electrical coil winding

- **Operation title: winding contactor coil.**
- **Purpose:** prepare contactor coil based on the requirements.
- **Instruction:** following each step below and given equipment prepare contactor coil. You have given 10 hr for the task and you are expected to complete all needed for the winding.

Tools, Equipment, and Materials

<u>ITEM:</u>	<u>QTY</u>
1. Defective contactor	1
2. Electrician tool set	1
3. Enameled copper wire	As required
4. Soldering equipment	1
5. Insulation tape	As required
6. Manual/automatic reminder	1

- **Steps in doing the task**

1. Select appropriate tools, materials and instruments for rewinding coil of contactor/solenoid.
2. Determine number of turn as shown in the theoretical part of this material.
3. Prepare coil on rewinding machine or manually.
4. Place the coil on the core properly and assemble it.

Page 91 of 124	Author/Copyright :- AGENA CONSTRUCTION AND INDUSTRIAL COLLEGE	Rewinding single/three phase induction machine	Version -1
			August, 2022



AGENA CONSTRUCTION AND INDUSTRIAL COLLEGE

5. Conduct functionality test on the apparatus and observe the result.

- **Quality Criteria:** the given machine specification affect greatly the performance characteristic of operation.
- **Precautions:** use PPE and always think that electric is your dangerous servant.

LAP Test 2: Wind contactor coil

Task 1: wind contactor coil properly to the standard and assemble it.

Page 92 of 124	Author/Copyright :- AGENA CONSTRUCTION AND INDUSTRIAL COLLEGE	Rewinding single/three phase induction machine	Version -1
			August, 2022



AGENA CONSTRUCTION AND INDUSTRIAL COLLEGE

Unit Three: Procedures to rewind single/three phase induction machine

This learning guide is developed to provide you the necessary information regarding the following content coverage and topics:

- Part dismantle, tag and store to prevent loss
- Techniques of striping winding from stator
- Procedure to wind and insulate Stator
- Inspection and testing of ac machine
- Completion of electrical coil work within timeframe
- respond unplanned situations in a manner that minimizes risk
- Quality checks on winding of induction machines

This guide will also assist you to attain the learning outcomes stated in the cover page. Specifically, upon completion of this learning guide, you will be able to:

- dismantle part, tag and store to prevent loss
- apply techniques of striping winding from stator
- follow procedures to wind and insulate Stator
- Inspect and test of ac machine
- complete electrical coil work within timeframe
- respond unplanned situations in a manner that minimizes risk
- apply checks on winding of induction machines

3.1. Part dismantle, tag and store to prevent loss.

Disassembling of machine needs careful producers so that the machine will not face difficulty for assembling which will result in malfunction of the entire system. For more practice operation sheet 3.1

3.2. Techniques of striping winding from stator.

Page 93 of 124	Author/Copyright :- AGENA CONSTRUCTION AND INDUSTRIAL COLLEGE	Rewinding single/three phase induction machine	Version -1 August, 2022
----------------	--	---	----------------------------



AGENA CONSTRUCTION AND INDUSTRIAL COLLEGE

First select proper equipment and tools for stripping the old coil from stator not to damage the slot as well as human injury. Think that working with heavy mechanically heavy machine.

3.3. How to Wind and insulate Stator:

Use proper insulation type and apply appropriately so that it can protect the winding.

3.4. Inspection and testing of ac machine

Inspection and testing of Ac motors is one of basic procedures after competing rewinding the motors to identify the motor whether rewound to the standard without affecting the original specifications. Testing may cover winding resistance testing, insulation resistance testing, speed testing, block rotor testing, high potential testing, and etc. Motor must be tested properly before applying it to the actual work otherwise it may cause material damage and human injury which may range to **Death!**

Quality standards are defined as documents that provide requirements, specifications, guidelines, or characteristics that can be used consistently to ensure that materials, products, processes, and services are fit for their purpose.

Standards provide organizations with the shared vision, understanding, procedures, and vocabulary needed to meet the expectations of their stakeholders. Because standards present precise descriptions and terminology, they offer an objective and authoritative basis for organizations and consumers around the world to communicate and conduct business.

Electric motor inspection testing is an important part of establishing the condition of the motor and the beginning the troubleshooting process. There are several different tests involved, and a basic knowledge of what the tests are can help you understand the repair data you receive back from your electric motor repair shop.

Winding Phase-to-Phase Resistance Test. **Winding phase-to-phase resistance tests** are used to detect any large differences in resistance that exist between the windings and is a common AC motor repair test. The resistance of each winding should essentially be the same. A standard low resistance ohmmeter is usually used for this type of test.

Page 94 of 124	Author/Copyright :- AGENA CONSTRUCTION AND INDUSTRIAL COLLEGE	Rewinding single/three phase induction machine	Version -1 August, 2022
----------------	--	---	----------------------------



AGENA CONSTRUCTION AND INDUSTRIAL COLLEGE

When IR to ground tests are being performed, it's important to keep in mind that there is a relationship between temperature and resistance: as the temperature changes, the resistance will change. For IR values to be meaningful, they need to be taken with a reference temperature for the winding, and then the IR values corrected to align with a 40°C standard reference temperature. This allows the IR results to be compared across multiple tests.

DC Hi-Pot Test: The DC hi-pot test, which can easily go up to 75,000V, serves as a stress test for the insulation and requires the use of a DC hi-pot tester. This is considered an over-voltage test because the voltage applied is higher than what the electric motor would normally be exposed to.

Surge Comparison Test. Electric motors go through both incoming and final surge comparison tests. The purpose of a **surge comparison test** is to detect insulation weaknesses and shorts (usually turn-to-turn, phase-to-phase, or coil-to-coil) as well as incorrect turn counts or improper internal connections. This type of test is performed with a multi-function surge tester.

Polarization Index Test: The **polarization index test** is essentially an insulation resistance to ground test that is performed over a 10-minute period. It provides information regarding the condition of the insulation with regard to moisture and cleanliness. This particular test is performed according to the IEEE 43-2000 standard. Once the data has been gathered, the value at the ten minute mark is divided by the value at the one minute mark to provide a ratio that is meaningful as it is tracked over time for a motor.

DC Voltage Drop Test. The **DC voltage drop test** is specific to DC motor repair and is the primary testing method used to identify shorted turns in the field windings of a DC motor, as well as the shunts, series, and interpoles. This test is performed by applying voltage to the shunt fields and interpoles and then measuring the voltage drop between the like feeds. And, even though this type of test is performed on DC motors, both AC and DC voltages can be applied. Using AC voltages at 60 Hz allows more problems to be detected.

A Note on Cleaning. There are times when the electric motor windings are dirty enough that they need to be cleaned before the condition of the windings can be accurately evaluated. If the IR values are too low, for example, it may be necessary to clean and bake the windings to obtain

Page 95 of 124	Author/Copyright :- AGENA CONSTRUCTION AND INDUSTRIAL COLLEGE	Rewinding single/three phase induction machine	Version -1 August, 2022
----------------	--	---	----------------------------



AGENA CONSTRUCTION AND INDUSTRIAL COLLEGE

more meaningful readings from the inspection tests. In fact, some windings may have test results that look like the winding needs to be replaced when all it actually needs is a thorough cleaning.

And this is especially common when it comes to DC motor armatures, where carbon and dirt can be hidden beneath the armature banding and commutator. As a result, the IR will be much lower than it should, but the primary problem is one of cleanliness and not a motor defect that requires a rewind.

Note that electric motor inspection test values are compared between the initial inspection test data and the final test data to ensure that improvements were made as a result of the repair or remanufacturing process.

3.5. Completion of electrical coil work within timeframe

Three major dimensions that define the work performance are scope, time, and resource.

These parameters are interrelated and interactive. The relationship generally represented as an equilateral triangle.

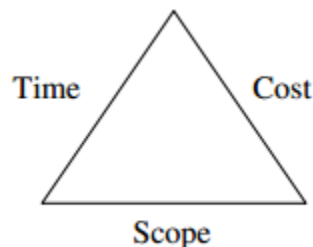

Figure 3.1 scope, time cost relation

It is evident that any change in any one of dimensions would affect the other. For example, if the scope is enlarged, project would require more time for completion and the cost would also go up. If time is reduced the scope and cost would also be required to be reduced. Similarly any change in cost would be reflected in scope and time. Successful completion of the project would require accomplishment of specified goals within scheduled time and budget. In recent years a fourth dimension, stakeholder satisfaction, is added to the project. However, the other school of management argues that this dimension is an inherent part of the scope of the project that defines

Page 96 of 124	Author/Copyright :- AGENA CONSTRUCTION AND INDUSTRIAL COLLEGE	Rewinding single/three phase induction machine	Version -1 August, 2022
----------------	--	---	----------------------------



AGENA CONSTRUCTION AND INDUSTRIAL COLLEGE

the specifications to which the project is required to be implemented. Thus the performance of a project is measured by the degree to which these three parameters (scope, time and cost) are achieved.

Mathematically

$$\text{Performance} = f(\text{Scope, Cost, Time})$$

As we waste time on work without any reason be sure that we are losing money. Completion of work within time frame is much important in rewinding work because a machine is waiting for its driver to be alive.

3.6. Respond unplanned situations in a manner that minimizes risk

Unplanned situation that are not foreseen prior to the need to change, often made necessary by working on it. Crisis Management is the process of preparing for, mitigating, responding to, recovering from, and learning from emergency incidents.

Crisis events unfreeze an organization's operational and procedural norms, making it necessary for organizational leaders to consider and implement changes that can be refrozen as the organization approaches a new period of equilibrium/convergence. During the period that the operational profile is unfrozen, an organization must implement changes that allow for an effective response to the crisis event and the insurance of organizational viability. Organizational changes made during crisis response are often unplanned and directive, guided by the foresight of organizational leaders. It is after the immediate threat of harm to organizational resources is absolved that planned changes can be made through participative processes.

3.7. Quality checks on winding of induction machines

The following attributes express the quality of induction machine.

- Coil quality it may be copper or aluminum.
- Insulation quality to resist current flow and temperature.
- Working within temperature limit as indicated by the manufacturer on the name plate data.

Page 97 of 124	Author/Copyright :- AGENA CONSTRUCTION AND INDUSTRIAL COLLEGE	Rewinding single/three phase induction machine	Version -1 August, 2022
----------------	--	---	----------------------------



AGENA CONSTRUCTION AND INDUSTRIAL COLLEGE

- Does not develop excessive vibration beyond expected from the designer.
- Long life cycle under proper operation depending on operational manual.
- Low impact on power system due to reactive power developed from inductive nature of machines.

Self-check 3

Test I: Multiple Choice

1. One of the following is not main task in rewinding work
 - a. collecting original data
 - b. Preparing complete winding diagram
 - c. varnishing and baking the motor
 - d. none
-
7. While testing insulation resistance between windings in a motor, the pointer of megger shall deflect to _____
 - a. 0 b. 0.5 c. 1 d. ∞
 8. A three-phase, wye-connected motor _____
 - e. Should never be started by a wye-delta controller.
 - f. Should always be started by a wye-delta controller.
 - g. Can be started by a wye-delta controller if proper timers are used.
 - d. can be started by a wye-delta controller if proper pushbuttons are used.
 7. Result/s which should be gathered while testing insulation resistance of Ac motor is/are:
 - a. Zero reading between U and V windings
 - b. Zero reading between U and V windings
 - c. Infinity reading between all windings and metallic body of motor

Page 98 of 124	Author/Copyright :- AGENA CONSTRUCTION AND INDUSTRIAL COLLEGE	Rewinding single/three phase induction machine	Version -1 August, 2022
----------------	--	---	----------------------------



AGENA CONSTRUCTION AND INDUSTRIAL COLLEGE

- d. Zero reading between all windings and metallic body of motor
9. Among the following given tasks to complete rewinding of machine, which on must be done before the others?
- a. Developing the winding diagram.
 - b. Collecting the original winding data.
 - a. Inserting coils in the cores.
 - b. Binding and varnishing the machine.
8. Motor testing method which does not need a voltage supply is;
- a. Earth resistance test
 - b. Phase sequence test
 - c. Revolution per minute test
 - d. Lock rotor test
10. Phase sequence test on induction motor is mainly used to:
- To determine the direction of motor
- a. To apply rated supply voltage
 - b. To determine supply frequency
 - c. For limiting starting current
11. Revolution per minute test on ac induction motor determines _____
- a. Actual speed (N)
 - b. Synchronous speed (Ns)
 - c. supply frequency
 - d. rotor frequency

Test-II True/False

- _____ 1. From cost factor always it is advisable to replace defective motor with new one instead of rewinding.
- _____ 2. Mechanical unfitness may result in electrical fault.
- _____ 3. If the megger reading is zero while conducting insulation resistance test the motor is defective one.
- _____ 4. To rewind induction motor it is not much important of developing winding diagram to be time effective.

Page 99 of 124	Author/Copyright :- AGENA CONSTRUCTION AND INDUSTRIAL COLLEGE	Rewinding single/three phase induction machine	Version -1 August, 2022
----------------	--	---	----------------------------



AGENA CONSTRUCTION AND INDUSTRIAL COLLEGE

_____.5. it is better to assemble ac induction motor without testing if you have limitations of testing instruments.

Test-III Short answer

1. Write down basic steps of rewinding induction motors.

2. What will be probable cause if the motor become overheated when tested with load?

Page 100 of 124	Author/Copyright :- AGENA CONSTRUCTION AND INDUSTRIAL COLLEGE	Rewinding single/three phase induction machine	Version -1
			August, 2022



AGENA CONSTRUCTION AND INDUSTRIAL COLLEGE

Operation Sheet 3.1 Three phase ac motor winding

- **Operation title:** Rewinding three phase AC motor
- **Purpose:** rewind three phase motor to the standards.
- **Instruction:** following each step below and given equipment prepare contactor coil. You have given 30hr for the task and you are expected to complete all needed for the winding.

Tools, Equipment, and Materials

Table 3.1 material and equipment list

	Item	Quantity
1	Defective three Ac motor	1
2	Electrician hand tools	1 set
3	Enameled copper wire/ magnet wire	As required
4	Motor/transformer automatic rewinding machine	1
5	Coil form (Bobbin)	1
6	Bench-Vise	1
7	Manual rewinder	1
8	Motor holder	1
9	Wire holder	1
10	Coil's removing machine	1
11	Baking oven	1
12	Coil's counter machine	1
13	Ohmmeter	1
14	Drawing scotch	As required

Page 101 of 124	Author/Copyright :- AGENA CONSTRUCTION AND INDUSTRIAL COLLEGE	Rewinding single/three phase induction machine	Version -1
			August, 2022



AGENA CONSTRUCTION AND INDUSTRIAL COLLEGE

15	Insulation tube	As required
16	Mylar/insulation paper	As required
17	Bearing puller	1
18	Varnish	As required
19	Wedge/bamboo	As required
20	Insulation tape	As required
21	Soldering with soldering lead	1
22	Oil/grease	As required
23	Insulating oil	As required

- **Steps in doing the task**

1: remove the burnout coil and clean the slots



Figure 3.2 removing burn out coil

2: prepare coil on by using manual rewinder or automatic rewinding machine

Page 102 of 124	Author/Copyright :- AGENA CONSTRUCTION AND INDUSTRIAL COLLEGE	Rewinding single/three phase induction machine	Version -1
			August, 2022



AGENA CONSTRUCTION AND INDUSTRIAL COLLEGE



Figure 3.3 coil preparation

3: cut and prepare insulation paper according to slot size



Figure 3.4 insulation preparation

4: Insert coils into slots based on the complete winding done under

Page 103 of 124	Author/Copyright :- AGENA CONSTRUCTION AND INDUSTRIAL COLLEGE	Rewinding single/three phase induction machine	Version -1 August, 2022
-----------------	--	---	----------------------------



AGENA CONSTRUCTION AND INDUSTRIAL COLLEGE



Figure 3.5 coil insertion

5: Insert insulation tube on start and end of coils.

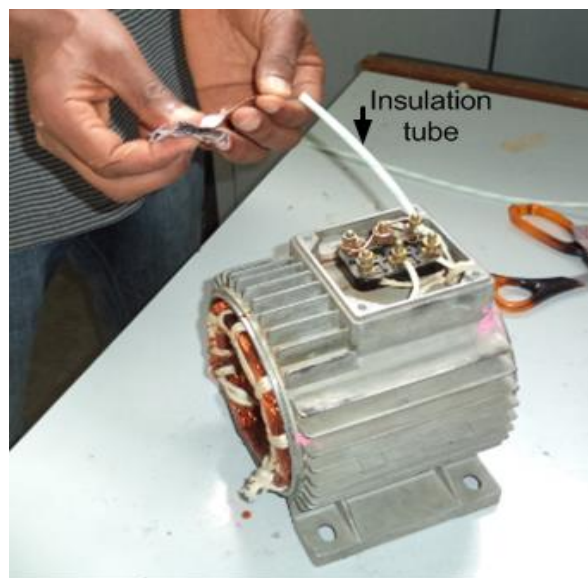

Figure 3.6 tube insertion

6: Bind the stator using copper rope

Page 104 of 124	Author/Copyright :- AGENA CONSTRUCTION AND INDUSTRIAL COLLEGE	Rewinding single/three phase induction machine	Version -1 August, 2022
-----------------	--	---	----------------------------



AGENA CONSTRUCTION AND INDUSTRIAL COLLEGE



Figure 3.7 binding

7: varnish the winding with appropriate amount



Page 105 of 124	Author/Copyright :- AGENA CONSTRUCTION AND INDUSTRIAL COLLEGE	Rewinding single/three phase induction machine	Version -1
			August, 2022



AGENA CONSTRUCTION AND INDUSTRIAL COLLEGE

Figure 3.8 Varnishing

8: Let varnish dry off from stator winding.

9: Assemble the motor accordingly



Figure 3.9 Assembling

- **Quality Criteria:** the given machine specification affect greatly the performance characteristic of operation.
- **Precautions:** use PPE and always think that electric is your dangerous servant.

Operation Sheet 3.2: Three phase ac motor winding

- **Operation title:** Testing Three phase Ac induction Motor
- **Purpose:** test the rewind three phase motor to the standards.
- **Instruction:** following each step below and given equipment test the rewind motor. You have given 8hr for the task and you are expected to complete all needed for the testing.

Page 106 of 124	Author/Copyright :- AGENA CONSTRUCTION AND INDUSTRIAL COLLEGE	Rewinding single/three phase induction machine	Version -1
			August, 2022



AGENA CONSTRUCTION AND INDUSTRIAL COLLEGE

Tools and test instruments

Table 3.3 material and equipment list

	Item	Quantity
1	Multimeter	1
2	Electrician hand tools	1 set
3	Tachometer	1
4	Rewound three phase Ac motor	1
5	Nut-spinner	1
6	Cable (three wire with ground)	1

Steps in doing the task

1: Measure winding resistance of each phase by setting multimeter to ohmmeter. Be sure all three winding resistance are balanced.

Page 107 of 124	Author/Copyright :- AGENA CONSTRUCTION AND INDUSTRIAL COLLEGE	Rewinding single/three phase induction machine	Version -1
			August, 2022



AGENA CONSTRUCTION AND INDUSTRIAL COLLEGE



Figure 3.11 resistance testing

2: Measure insulation resistance of motor using megger for all three phases (reading for each should be above $2M\Omega$) unless there will ground fault on motor.

Page 108 of 124	Author/Copyright :- AGENA CONSTRUCTION AND INDUSTRIAL COLLEGE	Rewinding single/three phase induction machine	Version -1
			August, 2022



AGENA CONSTRUCTION AND INDUSTRIAL COLLEGE

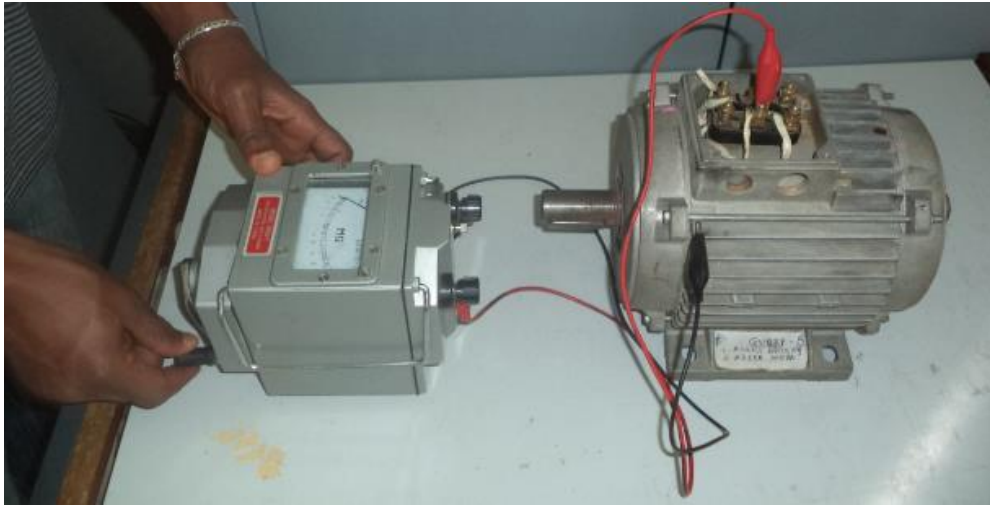

Figure 3.12 insulation resistance testing

3: Apply 380 volt to the motor from fused three phase socket outlet with switch. Switch on the power and measure the speed of motor using tachometer. **Note** that the motor is running mechanically in smooth way (noise free), and let it run for a long minutes to check whether it is getting hot (touch with your hand to check overheating). If there is trouble observed on the motor rewind again to remove faults detected while testing.

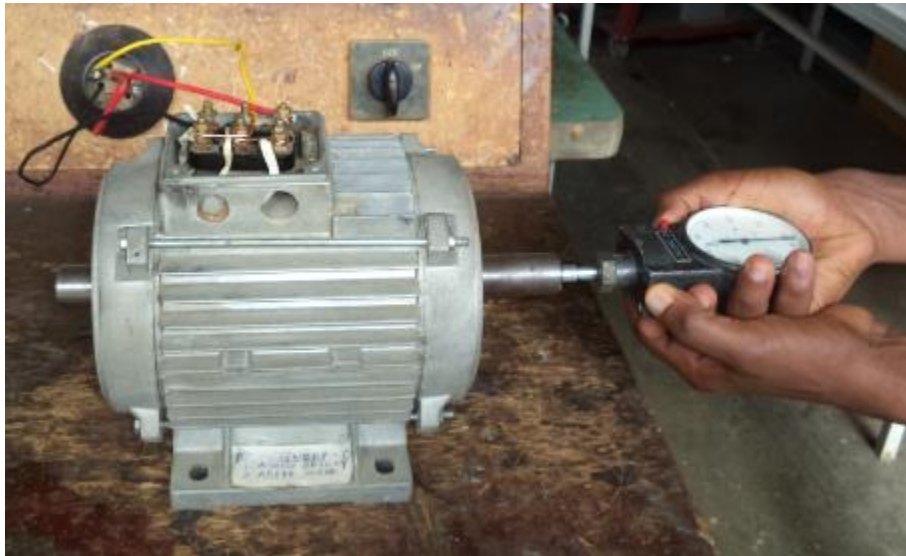

Figure 3.13 speed measurement

Page 109 of 124	Author/Copyright :- AGENA CONSTRUCTION AND INDUSTRIAL COLLEGE	Rewinding single/three phase induction machine	Version -1
			August, 2022



AGENA CONSTRUCTION AND INDUSTRIAL COLLEGE

- **Quality Criteria:** the given machine specification affect greatly the performance characteristic of operation.
- **Precautions:** use PPE and always think that electric is your dangerous servant.

LAP Test 3: Rewind of Three phase Ac induction Motor

Task 1: Rewind three phase ac motor by following due procedures.

Task 2: Perform testing on rewound motor.

Page 110 of 124	Author/Copyright :- AGENA CONSTRUCTION AND INDUSTRIAL COLLEGE	Rewinding single/three phase induction machine	Version -1
			August, 2022



AGENA CONSTRUCTION AND INDUSTRIAL COLLEGE

Unit Four: Completion of workplace report

This learning guide is developed to provide you the necessary information regarding the following content coverage and topics:

- Process of checking standards and requirements
- Procedures for checking assembled products
- Follow completion of workplace report/forms
- Completion of workplace report

This guide will also assist you to attain the learning outcomes stated in the cover page. Specifically, upon completion of this learning guide, you will be able to:

- Check standards and requirements
- Apply procedures for checking assembled products
- Follow completion of workplace report/forms
- Complete of workplace report

4.1. Process of checking standards and requirements

Why standards?

- Quality orientated process approaches and standards are maturing and gaining acceptance in many companies
- Standards emphasize communication and shared understanding For example: if one person says, “*Testing is complete*”, will all affected bodies understand what those words mean?
- This kind of understanding is not only important in a global development environment; even a small group working in the same office might have difficulties in communication and understanding of shared issues

Page 111 of 124	Author/Copyright :- AGENA CONSTRUCTION AND INDUSTRIAL COLLEGE	Rewinding single/three phase induction machine	Version -1 August, 2022
-----------------	--	---	----------------------------



AGENA CONSTRUCTION AND INDUSTRIAL COLLEGE

- Standards can help in these and other areas to make the business more profitable because less time is spent on non-productive work

Importance of standards

- Encapsulation of best practice
- avoids repetition of past mistakes
- Framework for quality assurance process
- it involves checking standard compliance
- Provide continuity
- new staff can understand the organisation by the standards applied

The **ISO 9000 series** of standards is the main set of International Standards applying to the management of quality systems. It includes ISO 9001, the key internationally agreed standard for a QMS. Businesses can be certified against this standard when they meet its requirements.

4.2. Procedures for checking assembled products

Check against design

Quality of design deals with the stringent conditions that the product or service must minimally possess to satisfy the requirement of the customer or organization. It implies that the product or service must be designed to meet at least expensive while still meeting the customer expectation. Quality of design is influenced by such factors as the type of product, cost profit policy of the firm, demand the product.

- Ensuring proper access control
- Identifying the retention period of quality records
- Ensuring the documents of external origin are identified and their distribution controlled.
- Preventing the unintended use of obsolete designs and to apply suitable identification to them if they are retained for any purpose.

Physical inspection

Page 112 of 124	Author/Copyright :- AGENA CONSTRUCTION AND INDUSTRIAL COLLEGE	Rewinding single/three phase induction machine	Version -1 August, 2022
-----------------	--	---	----------------------------



AGENA CONSTRUCTION AND INDUSTRIAL COLLEGE

It always using measurements depending on the manufacturer manual or specification, physical inspection mainly contain physical quantities such as;

- Length
- Time

Material specification

The engineering requirement for judging the acceptability of particular characteristics.

The specification contains

- Name of the material
- Manufactured year
- Manufacture country
- Serial number

Investigating Causes of deviations

- There are many factors which affects quality of out puts products /services these are
- Working tools
- Materials
- Machines
- Type of labor
- Working condition
- Measuring instrument

Continuous Improvement

- Philosophy that seeks to make never-ending improvements to the process of converting inputs into outputs.
- Kaizen: Japanese word for continuous improvement

Six Sigmas

Page 113 of 124	Author/Copyright :- AGENA CONSTRUCTION AND INDUSTRIAL COLLEGE	Rewinding single/three phase induction machine	Version -1 August, 2022
-----------------	--	---	----------------------------



AGENA CONSTRUCTION AND INDUSTRIAL COLLEGE

- Six Sigmas: A business process for improving quality, reducing costs, and increasing customer satisfaction
- Statistically
 - Having no more than 3.4 defects per million
- Conceptually
 - Program designed to reduce defects
 - Requires the use of certain tools and techniques

Six Sigma Programs

- Improve quality
- Save time
- Cut costs

Employed in

- Design
- Production
- Service
- Inventory management
- Delivery

Six Sigma Management

- Providing strong leadership
- Defining performance metrics
- Selecting projects likely to succeed
- Selecting and training appropriate people

Six Sigma Technical

- Improving process performance
- Reducing variation
- Utilizing statistical models
- Designing a structured improvement strategy

Page 114 of 124	Author/Copyright :- AGENA CONSTRUCTION AND INDUSTRIAL COLLEGE	Rewinding single/three phase induction machine	Version -1 August, 2022
-----------------	--	---	----------------------------



AGENA CONSTRUCTION AND INDUSTRIAL COLLEGE

4.3. Follow completion of workplace report/forms

Table 4.1 Checklist for rewind motor

	Points to checked	Report/Record defects	Remark
1	Rewinding materials are selected		
2	External data of motor is taken properly and recorded		
3	Internal data of motor is taken properly and recorded		
4	Complete winding diagram is developed as per the original data.		
5	Coils are properly prepared on the former		
6	Slots are properly insulated		
7	Coils are inserted properly to the slots		
8	Coils are connected to the different group properly		
9	The winding is binded and backed properly		
10.	The rewind motor is tested for its proper operation		

Page 115 of 124	Author/Copyright :- AGENA CONSTRUCTION AND INDUSTRIAL COLLEGE	Rewinding single/three phase induction machine	Version -1
			August, 2022



AGENA CONSTRUCTION AND INDUSTRIAL COLLEGE

11	The motor is properly assembled to the load (drive system)		
12	equipment and any excess resources materials and tools, , are cleaned, checked and returned to storage area in accordance with enterprise procedures		
13	work area is cleaned and made safe in accordance with OHS requirements		

Reported By _____ Signature. _____ Date _____

4.4. Completion of workplace report

What is a work report?

A work report is a formal document that discusses information about a specific topic related to an aspect of your job. Most work reports are addressed to a particular audience, such as a manager. Depending on the type of work report, you may be given a report brief that outlines what you should include in your report. Most reports should be written in a structured format to clearly demonstrate what the report is trying to convey.

Related: 5 Steps for Great Business Writing (With Tips)

How to write a work report

Writing effective work reports takes practice and requires good communication skills. The more reports you write, the more efficient you will be in composing them. The following are steps you can take to write a professional report in the workplace:

1. Identify your audience

Page 116 of 124	Author/Copyright :- AGENA CONSTRUCTION AND INDUSTRIAL COLLEGE	Rewinding single/three phase induction machine	Version -1 August, 2022
-----------------	--	---	----------------------------



AGENA CONSTRUCTION AND INDUSTRIAL COLLEGE

Knowing who will be reading your report is an important step in determining how you will format your report, what to include and the tone you should use when writing it. For example, if you are writing a sales report for your manager, will anyone else be reading the report? If you're composing a business analysis report, will your higher-ups be reading the report or only your immediate supervisor? Establish who will be reading your report and cater the report to these specific people.

2. Decide which information you will include

After determining who your audience is, you should focus on identifying the purpose of your report to decide what information should be included. If you know who will be reading the report, you could ask questions regarding what they expect to see. Choose to include information that will provide the clearest picture of what you are trying to convey.

For example, if you're writing a sales report, your report may need to include information about whether sales goals are being met, products and services that are selling the most, challenges you or your team are facing and your sales forecast for the next month or quarter.

Related: How To Create an Analytical Report (And Why It's Important)

3. Structure your report

When writing a report, you should structure it so that it can be easily read and digested. While each report will vary in the sections you should include, you can use the following report components as a guide when writing your report:

Title or title page

Executive summary/abstract that briefly describes the content of your report

Table of contents (if the report is more than a few pages)

An introduction describing your purpose in writing the report

A body paragraph where you include the information you are conveying with the report

Conclusion or recommendation depending on the purpose of the report

Related: What Are Project Deliverables? Types and Example

4. Use concise and professional language

Page 117 of 124	Author/Copyright :- AGENA CONSTRUCTION AND INDUSTRIAL COLLEGE	Rewinding single/three phase induction machine	Version -1 August, 2022
-----------------	--	---	----------------------------



AGENA CONSTRUCTION AND INDUSTRIAL COLLEGE

You should strive to use clear and concise language when writing your report. Try to get the point across as clearly and quickly as possible and use simple yet professional language. Avoid using "fluff" or wordy sentences when possible. For example, rather than saying, "You might find it helpful to regularly refresh your inbox to stay up-to-date on emails," you could say, "Regularly refresh your inbox."

Related: [How To Speak More Concisely \(With 6 Steps You Can Follow\)](#)

5. Proofread and edit your report

Proofreading your work report is an essential step in the report-writing process. This gives you the opportunity to ensure your writing is as professional as possible and to catch any mistakes before you send it out. Proofreading also allows you to cut out any unnecessary information and make sure your report is as efficient and effective as possible.

Once you have finished writing your report, set it aside for an hour or more before you proofread it. This will allow you to look at the report in a fresh way and catch mistakes you may not have seen before.

Related: [Guide to Memo Writing with Tips and Examples](#)

Work report template

The following is a template you can use when formatting a work report:

[Project name]

[Date]

[Prepared by: your first and last name]

[Company name]

[Executive summary or abstract: Use this section to note your conclusions or recommendations that will be made in the report. You should also include the most important ideas discussed in the report. If you're writing a daily work report or progress report, you do not need to include this section.]

[Introduction: Your introduction should be two to four paragraphs summarizing what you will cover in the report as well as your reason for writing the report. Be as specific and concise as

Page 118 of 124	Author/Copyright :- AGENA CONSTRUCTION AND INDUSTRIAL COLLEGE	Rewinding single/three phase induction machine	Version -1 August, 2022
-----------------	--	---	----------------------------



AGENA CONSTRUCTION AND INDUSTRIAL COLLEGE

possible when writing your introduction so that the reader can clearly understand what they will find in your report. For daily or progress reports, your introduction only needs to be a few sentences detailing work you've completed and what you plan to work on next.]

[Body: For the body of your report, you should focus on detailing the information you wish to convey. You can include results, conclusions and findings that were made related to a project. For daily or progress reports, include the accomplishments you have achieved or tasks you have completed.]

[Recommendations: In this section, you should list your recommendations based on the conclusions or results of a project or that will solve a particular issue. For example, you may write "spend one hour training employees.]

Page 119 of 124	Author/Copyright :- AGENA CONSTRUCTION AND INDUSTRIAL COLLEGE	Rewinding single/three phase induction machine	Version -1
			August, 2022



AGENA CONSTRUCTION AND INDUSTRIAL COLLEGE

Self check 4

Test I Multiple Choice

1. Importance of standards
 - a. Encapsulation of best practice
 - b. avoids repetition of past mistakes
 - c. Framework for quality assurance process
 - d. it involves checking standard compliance
 - e. all

2. Procedures for checking assembled products
 - a, check against design

 - b, Physical inspection

 - c, Material specification

 - d, Investigating Causes of deviations

3. Six Sigma Programs
 - a, improve quality
 - b, save time

Page 120 of 124	Author/Copyright :- AGENA CONSTRUCTION AND INDUSTRIAL COLLEGE	Rewinding single/three phase induction machine	Version -1
			August, 2022



AGENA CONSTRUCTION AND INDUSTRIAL COLLEGE

c. cut costs

Test II Short Answer

_____1. Quality of design deals with the stringent conditions that the product or service must minimally possess to satisfy the requirement of the customer or organization

_____2. Quality orientated process approaches and standards are maturing and gaining acceptance in many companies.

_____2. The **ISO 9000 series** of standards is the main set of International Standards applying to the management of quality systems.

Test III Short answer

1. What are the important of standards?

2. Explain physical inspection by relating to motor rewinding.

Page 121 of 124	Author/Copyright :- AGENA CONSTRUCTION AND INDUSTRIAL COLLEGE	Rewinding single/three phase induction machine	Version -1
			August, 2022



AGENA CONSTRUCTION AND INDUSTRIAL COLLEGE

Operation Sheet 4. Workplace report

- **Operation title:** Reporting completion of rewinding task a motor
- **Purpose:** report completed work on the rewind motor by comparing to the checklist.
- **Instruction:** following each step below and given equipment write report based on your findings against the checklist on the rewind motor. You have given 4hr for the task and you are expected to complete all needed.

	Item	Quantity
1	Paper	As required
2	Secretary office	optional

- **Steps in doing the task**

1: Based on your progress from data collection up to testing of rewind motor write complete report.

2: Be sure to use standard format and true data from your findings.

- **Quality Criteria:** the given machine specification affect greatly the performance characteristic of operation.
- **Precautions:** use PPE and always think that electric is your dangerous servant.

LAP Test 4: Report writing

Task1. Write complete workplace report based on your findings from rewinding.

Page 122 of 124	Author/Copyright :- AGENA CONSTRUCTION AND INDUSTRIAL COLLEGE	Rewinding single/three phase induction machine	Version -1
			August, 2022



AGENA CONSTRUCTION AND INDUSTRIAL COLLEGE

Reference

Books

- Electrical Machines and Appliances: A publication under Government of Tamilnadu Distribution of Free Textbook Programme.
- Electrical machines I; Module I: 2016-2017 Edition Fadhl A. Hasan University of Technology Department of Electrical Engineering.
- Induction Motors: Phase 2, Module NO 2.4.1 Course Notes

Internet sources

- Wikipedia.org
- Wikianswers.com
- www.engineeringtoolbox.com
- Google image
- <https://books.google.com>
- <https://new.abb.com/low-voltage/products/motor-protection>

Page 123 of 124	Author/Copyright :- AGENA CONSTRUCTION AND INDUSTRIAL COLLEGE	Rewinding single/three phase induction machine	Version -1 August, 2022
-----------------	--	---	----------------------------



AGENA CONSTRUCTION AND INDUSTRIAL COLLEGE

Participants of this Module (training material) preparation

No	Name	Qualification (Level)	Field of Study	Organization/ Institution	Mobile number	E-mail
1	Hailu Habte	C	Industrial Automation & Control Tech	ACIC	0926067053	
2	Israel Moltotal	A	Electrical Automation & Control Tech	ACIC	0911026069	
3	Samson Abebe	B	Electrical Automation & Control Tech	ACIC	0924406035	
4	Yetsedu Melku	B	Electrical/Electronic Technology	ACIC	0922984461	
5	Abreham Shigaze	B	Electrical Automation & Control Tech	ACIC	0922343843	
6	Mosa Sani	B	Electrical Automation & Control Tech	ACIC	0920353299	
7	Jember Shewalem	B	Electrical Automation & Control Tech	ACIC	0912354396	



AGENA CONSTRUCTION AND INDUSTRIAL COLLEGE